

LIVART Office

CATALOGUE 2020 REV.0

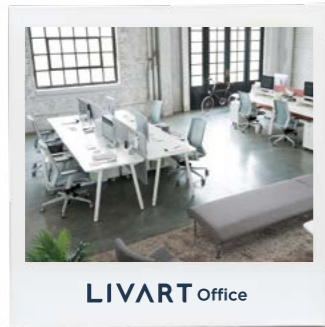



LIVART Office



LIVART Haum



LIVART Marine

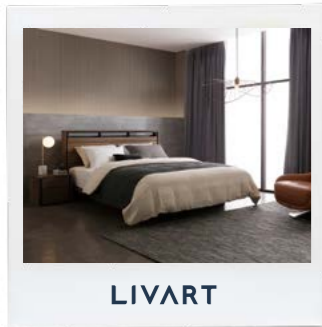

LIVART

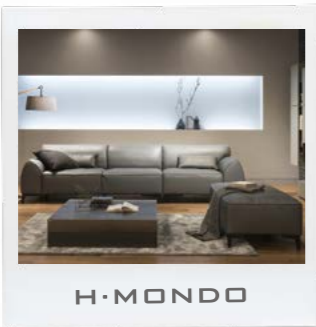

H-MONDO



LIVART Kids

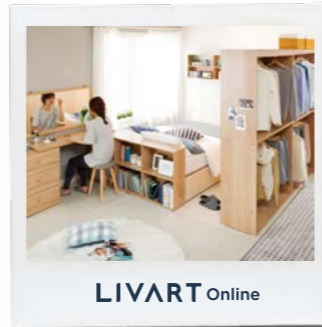

LIVART Online



LIVART Chairs

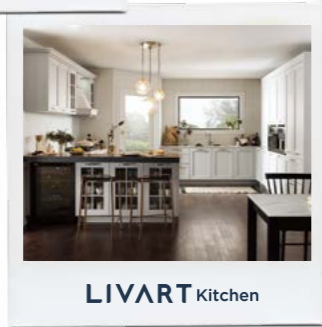

LIVART Kitchen

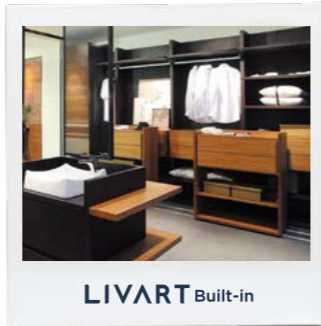

LIVART Built-in

LIVART Office
CREATIVE Office... LIVART Office

공간으로 경험하다

리바트를 만나는 순간
고객의 행복은 시작됩니다





현대리바트는 고객의 행복을 위해
가치 있는 공간과 서비스를 제안 드리겠습니다.

We, Hyundai LIVART, offers valuable space and services to
our customers for their happiness.

Creative Office

효율성과 기능성을 넘어 창의적인 아이디어가 강조되고 있습니다.
크리에이티브 오피스를 위한 다양한 제품을 만나보세요.
Beyond efficiency and functionality, creative ideas are being emphasized.
Meet a various range of products for creative offices.

Communication

다양한 방식의 소통을 지원하는 크리에이티브 오피스
원활한 소통은 크리에이티브 오피스가 기능하기 위한 가장 기본적인 원칙입니다.
Creative office that supports communication in various ways
Smooth communication is the most basic principle for the creative office to function.

Agile

변화에 민첩하게 대응할 수 있는 크리에이티브 오피스
변화의 속도는 점점 더 빨라지고 있습니다.
Creative office that is agile enough to respond to these change
The speed of change is getting faster.

Deversity

다양한 업무 형태를 지원하는 크리에이티브 오피스
개인의 특성을 존중하고, 다양성을 활용하는 것이 기업의 핵심이 되고 있습니다.
Creative office that supports a wide variety of business types
Respecting individual characteristics and leveraging diversity are becoming core value of a company.

더 나은 오피스 공간만을 생각하는 리바트오피스 LIVART OFFICE which devotes to provide better workplace

하루 대부분의 시간을 보내는 사무공간에서 우리는 사용자가 더 행복하고 값진 경험을 가질 수 있는 방법을 고민합니다. 우리는 사용자의 사무환경이 더 가치 있고, 본질에 집중하며, 진정성 있는 제품으로 채워질 수 있도록 리바트의 40년 노하우로 공간을 완성합니다

We are thinking about how the users could be more happy and have valuable experience in the workplace where they spend most of the day. We complete the workspace with LIVART's 30 years of accumulated know-how and ensure that the office environment of the user can be more valuable, be focused on the essence and be filled with thoughtful products.

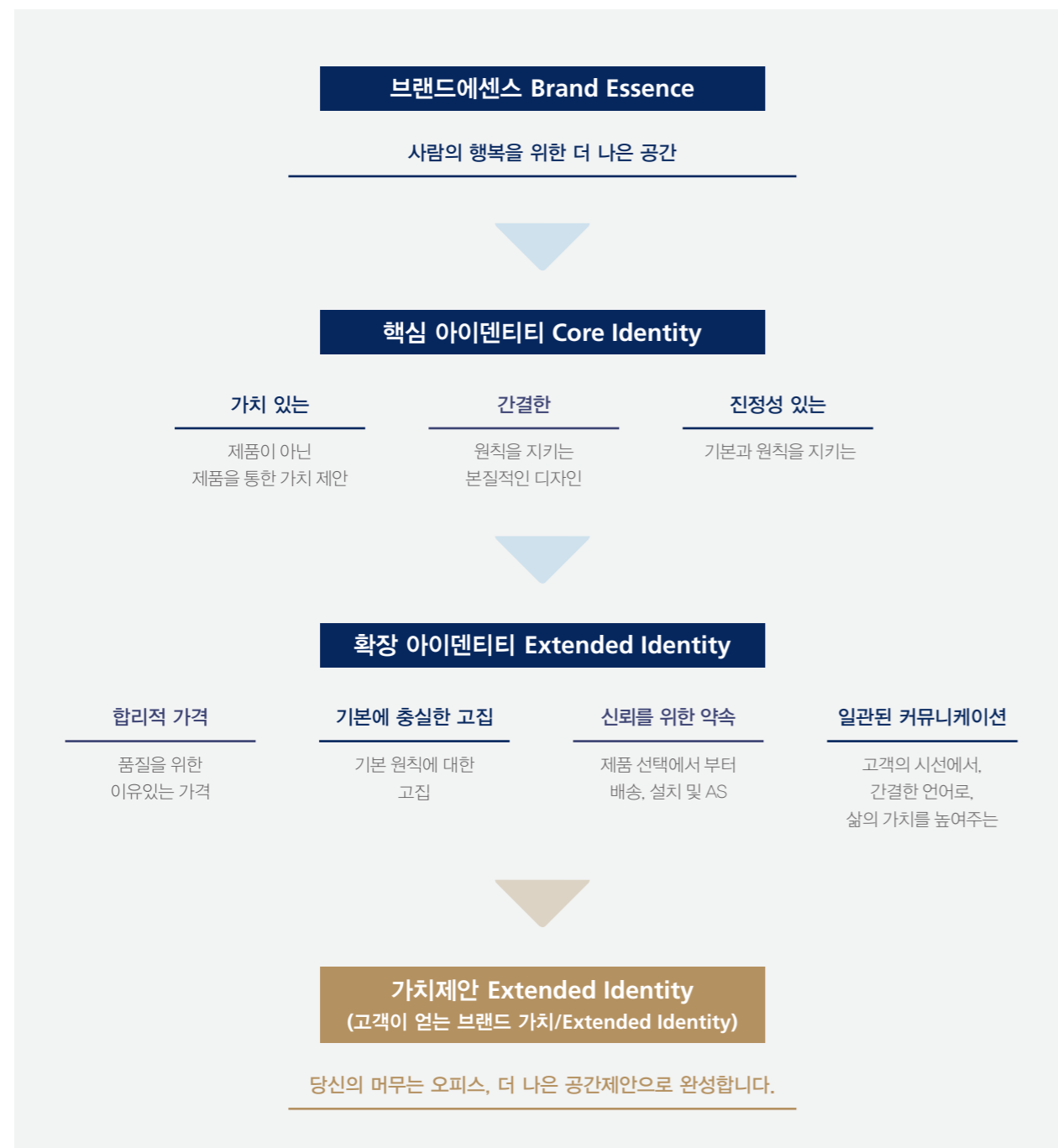

리바트오피스만의 고객을 위한 3가지 약속 3 promises of the LIVART OFFICE for customers

고객이 감동하는 쾌적한 생활환경을 조성하고 환경을 보존하는 현대리바트!
현대리바트라는 이름, 그것은 품질에 대한 신뢰입니다.

‘가구에 영혼을 불어넣는 일’, 현대리바트는 그것을 디자인이라 말합니다.

Hyundai LIVART creates a pleasant living environment and preserves the environment for its customers!

The name Hyundai LIVART, it symbolizes trust in quality.

“Bringing souls to furniture,” Hyundai Livart calls it design.

ECO LIVART

현대리바트는
가구 브랜드이기 전에
친환경 브랜드입니다.

Hyundai LIVART is not a
just normal furniture brand,
but is an eco-friendly
furniture brand.



국내가구업계 최초 환경표지인증 획득 The Industry's First Eco-Label

현대리바트는 끊임없는 친환경 연구
와 기술개발로 국내 가구업계 최초로
환경표지인증(환경마크)을 획득하였
습니다. 앞으로도 현대리바트는 건강
한 가구 생산으로 친환경 기업의 리더
로서 그 역할을 다할 것입니다.

QUALITY LIVART

최고의 품질이 아니면
현대리바트의 이름을
허락하지 않습니다.

We do not allow the
name of Hyundai LIVART
unless it is of the highest
quality.



퀄리티 리더 철학

Quality Leader Philosophy

현대리바트는 환경을 위한 기술 개발
과 품질 경영의 적극 실현을 통해 ‘고객
의 삶의 공간을 예술로 디자인’하는 사
명을 달성하여 21세기를 선도하는 세
계 일류기업을 실현하고자 합니다.

DESIGN LIVART

간결함으로
진정성을 담은 디자인을
추구합니다.

We pursue the design
with simplicity and sincerity.



트렌드 선도 디자인

Trendsetting Designs

빠르게 변화하는 라이프 스타일을 앞
서 제안하고 고객이 원하는 가치를 실
현하고자 매년 디자인연구소를 통해
가구 디자인 트렌드를 발표하고 있으
며, 더 나은 공간을 고객이 행복하게 경
험하도록 진심과 디테일을 담은 디자
인을 추구합니다.

다양한 공간 전문가들로 구성된 현대리바트 Hyundai LIVART with various space experts

1본부 1총괄 10사업부 2센터 43팀 80파트 2TFT 3해외법인
1 HQ 1 Oversight Division 10 Divisions 2 Center 43 Teams 80 Parts 2TFT 3 Overseas Subsidiaries

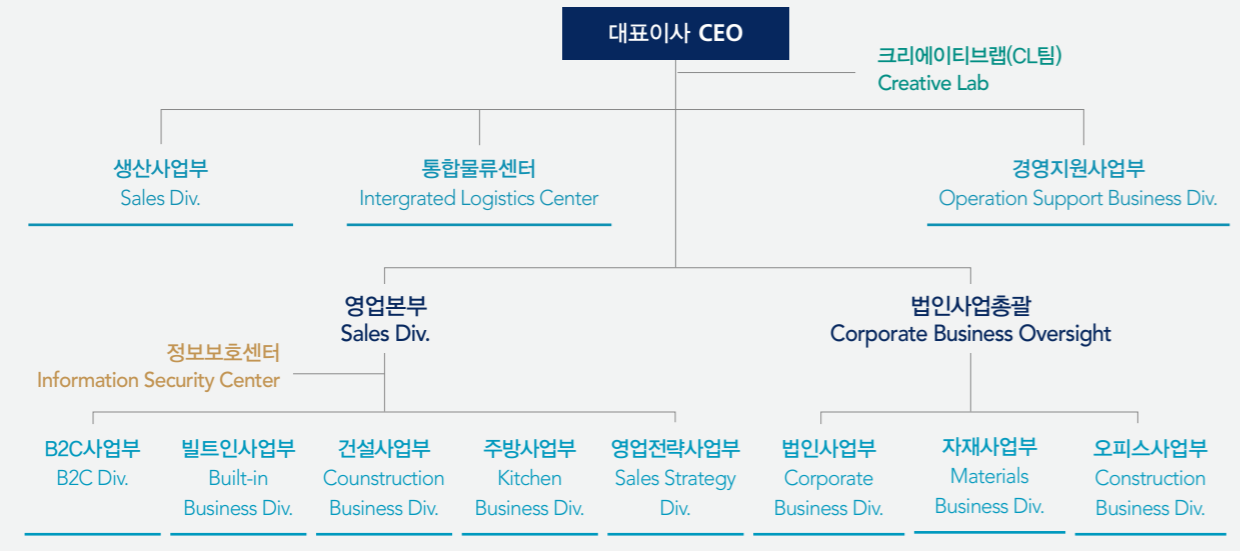

최고의 제품을 위한 품질 경영 Creative Communication Typetive

LIVART 5R 리바트 환경경영 5R

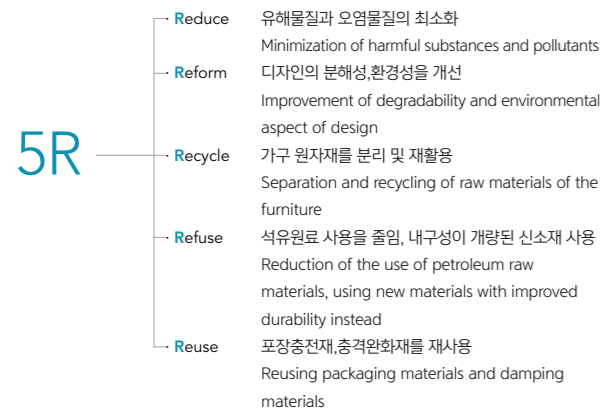

ECO FRIENDLY 친환경 자재

인체 유해 물질 및 환경 오염 물질이 환경부 기준에 비해 더 낮은 수치는 친환경 가구로서의 약속입니다.
The lower value of harmful substances and environmental pollutants compared to standards of Ministry of Environment is a promise made for customers as an eco-friendly furniture company.

- EO등급 목질, 보드, PP표면재를 사용하며, 포름알데히드 방출이 전혀 없는 건식 무늬목을 사용합니다.
- 용제형 접착제가 아닌 수성접착제를 사용하여 인체에 무해하게 생산합니다.
- 소각 시 다이옥신이 방출되는 비닐을 사용하지 않고, 친환경 소재인 합성 모양지를 대체 사용합니다.
- EO grade wood, board, and PP surface materials are used and dry veneer with no formaldehyde emission is used.
- An aqueous adhesive rather than a solvent-based adhesive is used to produce furniture in a harmless way.
- When incinerating, dioxin-releasing vinyl is not used and is replaced by environment-friendly impregnated paper.

Step 1

자체물성 보증
Use of own physical properties guaranteed
가구 제작 전 자재의 기본적인 물성 분석
Basic physical properties analysis of materials before making furniture

Step 2

부품 중간 검사
Intermediate inspection of parts
부품화 단계에서의 변질, 변형 방지 검사
Deterioration and deformation prevention test at the modularization stage

Step 3

공정관리
Processing Management
공정 중 결점 개선, 보완 및 관리
Improvement, complement and management of defects during processing

Step 4

완제품 마감검사
Finished product inspection
소비자 인도 전 엄밀 조사
Strict investigation before delivery to consumers

리바트오피스만의 전문화된 오피스 컨설팅 프로세스 LIVAT OFFICE's one and only specialized office consulting process

사무환경은 우리가 단순히 일을 하는 공간만이 아니라 우리의 삶의 방식과 밀접하게 연관되어 보다 많은 고민과 전문성이 필요합니다. 사무환경 컨설팅 전문기업 리바트오피스가 최적화된 사무환경을 제안할 것을 약속합니다.

STEP 1 기획

사용자 및 공간 분석 Basic Planning

사용자 설문조사, 그룹 인터뷰 등을 통하여 사용자가 느끼는 현재의 문제점을 파악합니다.
사용자의 업무성과를 극대화 할 수 있도록 부서별 업무방식 및 업무연관성을 파악합니다.

STEP 2 계획

공간 컨셉 및 구성 계획 Space Planning

사무공간 이용현황, 동선에 대한 진단하고 공간을 효율성과 가치를 높일 수 있도록 연구합니다.
각 부의 업무특성에 맞는 워크스테이션을 설계하고 적합성을 검토합니다.

STEP 3 설계

공간 세부 설계 Design

사용자의 니즈를 정확하게 파악한 전체 공간 배치 및 워크스테이션 계획을 완성합니다.
공간의 전체 이미지와 컨셉에 맞도록 세부 색채 설계와 디테일을 결정합니다.

STEP 1

사용자의식 조사 및 분석
Research and analysis on user perception

STEP 2

공간 조사 및 분석
Research and analysis on space

STEP 3

각부 상관관계조사
Investigation on correlation between divisions

STEP 4

오피스 컨셉 설정
Setting up office concept

STEP 5

동선 및 zoning
Flow of human traffic / Moving lines and zoning

STEP 6

워크스테이션 검토
Workstation review

STEP 7

구체적인 공간 제안
Specific space proposal

STEP 8

가구 레이아웃 설계
Furniture layout design

STEP 9

색채설계
Color design

지금 우리에게 필요한 창의적으로 일하는 공간, Creative Office Creative Office, a creative workplace we need at the moment

업무환경의 변화는 반드시 기업의 핵심 가치를 이해하고 그 방법의 하나로 실현되어야 합니다. 우리 기업이 추구하는 가치를 만들어 내기 위해 더 효율적이며 생산적인 업무환경을 가질 수 있는 방법을 고민하고 더 나아가 새로운 솔루션을 제공하는 것, 리바트오피스는 이것을 '크리에이티브 오피스'라고 생각합니다.

Creative Office

Solution

기업문화와 WorkingDNA 분석을 통해 유/무형의 시스템을 고안하고 구체적인 방법을 찾아 성과라는 핵심가치 실현하는 것
Corporate Culture and Working DNA
Through analysis, we devise tangible/intangible systems and find specific methods to realize the core value of performance.

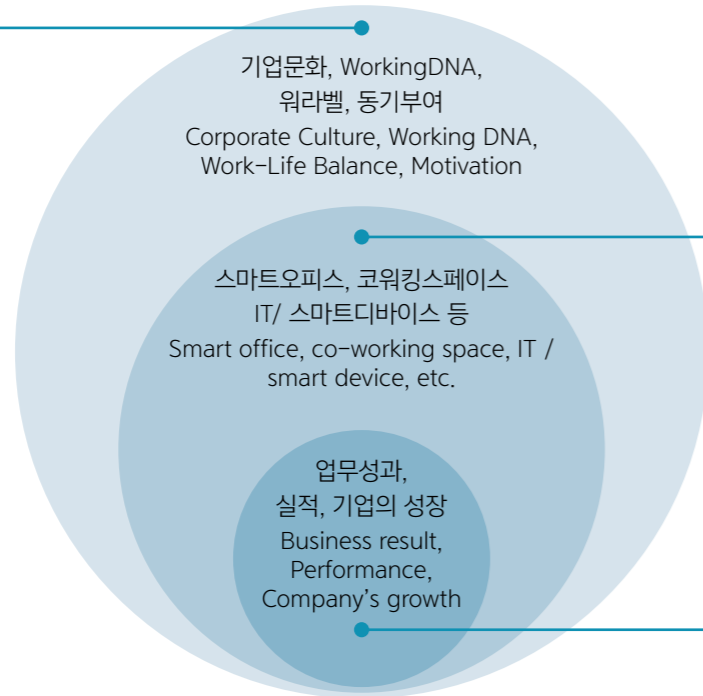

Method

효과적으로 성과를 낼 수 있는 방법 혹은 방식을 제공하는 시스템 / 공간
Systems / spaces that provide a way or method for achieving results effectively

Core Value

업무를 수행하고 최고의 성과를 내는 것
Do work and achieve the best result

새로운 오피스의 방향 Co-Work Direction of the New Office, Co-Work

크리에이티브 오피스는 구성원이 '함께 일하며 시너지를 내는 것'에서 부터 시작합니다. 구성원 모두가 함께 일하는 유연한 근무환경과 직원들이 느끼는 실질적인 베네핏을 만족 시켰을때 가장 큰 시너지를 낼 수 있습니다. 리바트오피스의 크리에이티브 오피스는 구성원의 역량을 이끌어 낼 수 있는 솔루션을 제공합니다.

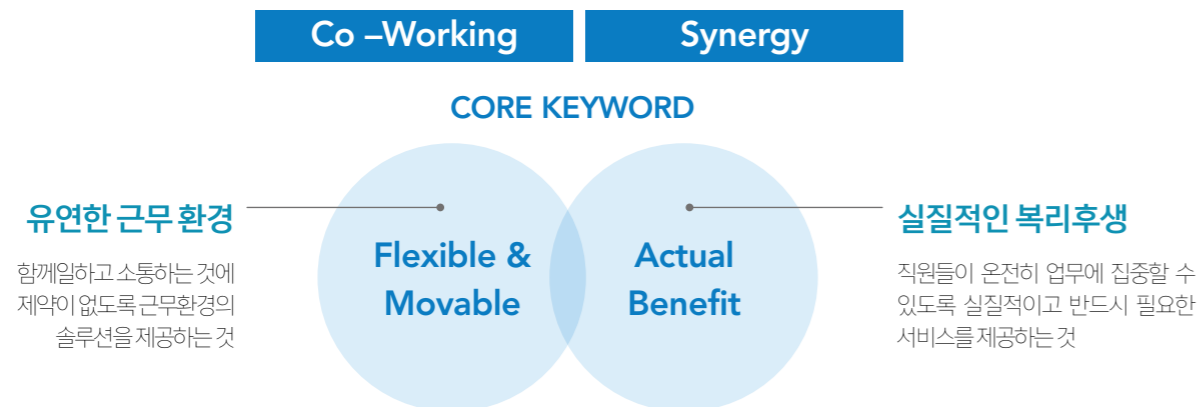

Creative Office를 경험할 수 있는 Showroom Showroom for experiencing Creative Office

사무공간을 스마트하게 변화시키는 솔루션을 경험해보세요.
전국 가까운 거점에 전시장에서 리바트오피스의 크리에이티브 오피스와 전문 컨설턴트를 만나보세요.

Showroom Information



서울송파전시장 Seoul Songpa

서울특별시 송파구 송이로 136 폭스바겐 빌딩 3, 4층
3rd and 4th Floors, Volkswagen Building, 136, Songi-ro, Songpa-gu, Seoul
Tel. 02-540-3693 / 82-02-540-3693



부산전시장 Busan

부산광역시 해운대구 해운대로 743 정우빌딩 5층
5th Floor, Jeongwoo Building, 743, Haeun-daero, Haeundae-gu, Busan
Tel. 051-791-0710 / 82-51-791-0710



대전전시장 Daejeon

대전광역시 대덕구 계족로 552 1,2층 운영사무실
1st and 2nd floors, Operating Office, 552, Gyejok-ro, Daedeok-gu, Daejeon
Tel. 042-710-0760 / 82-42-710-0760



수지전시장 Gyeonggi Suji

경기도 용인시 수지구 수지로 422
422 Suji-ro, Suji-gu, Yongin-si, Gyeonggi-do
Tel. 031-265-0701 | 82-31-265-0701

Showroom

Factories



울산전시장 Ulsan

울산광역시 북구 명촌10길 62
62, Myeongchon 10-gil, Buk-gu, Ulsan
Tel. 052-289-4358
| 82-52-289-4358



광주전시장 Gwangju

광주광역시 서구 상무대로 903
908 Sangmu-daero, Seo-gu, Gwangju
Tel. 062-941-9600
| 82-62-941-9600



용인 본사 Yongin HQ

경기도 용인시 처인구 남사면 경기동로 316
316, Gyeonggidong-ro, Namsa-myeon, Cheoin-gu, Yongin-si, Gyeonggi-do
Tel. 1577-3332 | 82-1577-3332



안성 공장 Anseong

경기도 안성시 공도읍 기업단지 122-1
122-1, Gieopdanji-ro, Gongdo-eup, Anseong-si, Gyeonggi-do
Tel. 070-7204-4405 | 82-70-7204-4405

자율좌석 타입 Hot desking Type SF4

외근의 비중이 높고 직원간의 협업과 소통이 많은 직군은 보다 개방적인 오피스 환경이 필요합니다. SF5 시리즈의 유럽형 디자인은 소통과 협업에 적합한 오픈형 오피스 구성에 적합합니다. 자율좌석제, 호텔링 등 다양한 업무방식에 유연하게 대응이 가능합니다.

Job category in which working outside is frequent and requires a lot of teamwork and communication requires more opened office environment. European design SF5 Series fits for open types of office focusing on communication and cooperation Flexible seating position such as free seating system, hoteling, etc.



데스크 SDD40016LD 서랍 FDB70020P 데스크선반 SDBS40010
소파 SSFO40003 의자 TOH50352L / TOH50332L

MOBILE A

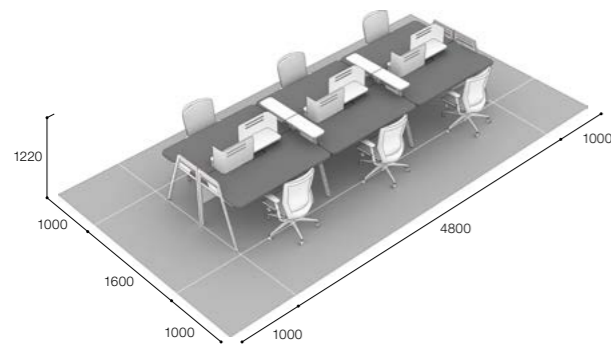

데스크	SSD40014HD
데스크선반	SDBS40010
사이드선반	SS40002

MOBILE B

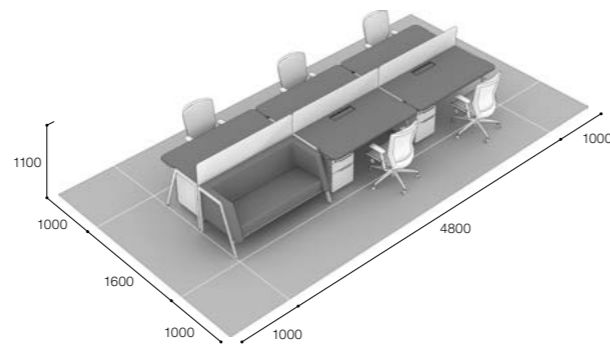

데스크	SSD40016LD
서랍	FDB70020P
스크린	SSP50016F
소파	SSFO40003

창의소통 타입 Creative Communication Type Easy Linker

내근 비중이 높은 편이지만 팀간 혹은 유관부서와의 협업의 비중이 증시되는 직군은 자유로운 커뮤니케이션이 가능해야 합니다. SF5 시리즈는 파티션의 높이를 낮추고 이동이 가능한 독립형 수납장과 스탠딩 회의를 진행할 수 있는 전통데스크를 갖추어 소통형 오피스 구축을 지원합니다.

Job category in which most office work are done in-door, but emphasizes teamwork with other teams or departments must be able to communicate freely. SF5 series shall support building of communication type office by having a vibration desk which lowers height of partition, along with enabling to have independent shelf which is able to move and process standing meeting.



(좌측 세트) 데스크 우레탄형 H010792 서랍 H010358 의자 TOH55852LWDG 스크린 H010796
(우측 세트) 데스크 H010454 서랍 H010359 의자 MOH15391 스크린 H010797

FLEX A

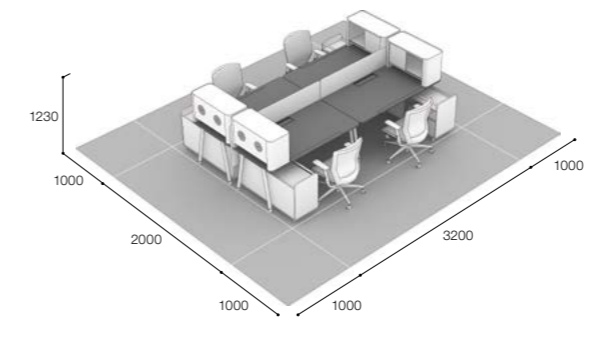

데스크	SDD50016UD
상부장	SSU50008
하부장	SSB850011(L/R)
스크린	SSP50016F

FLEX B

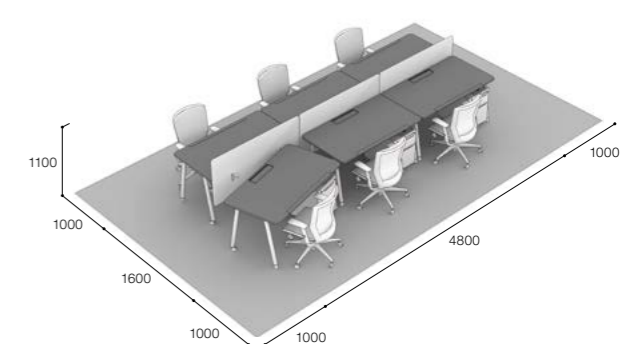

데스크	H010443-50
서랍	FDB70020P
스크린	SSP50016F / SSP50008F

집중업무타입 Focus work type NF8 801

내근 위주의 개인 집중 업무 비중이 높은 직군은 업무에 집중할 수 있는 독립적인 환경이 필요합니다. NF8 801 시리즈는 다양한 수납장과 파티션을 통해 집중형 1인 워크 스테이션과 레이아웃을 지원합니다.

Job category which is mainly based on in-door working and individual-based duties requires independent environment which enables to focus on work.

Neoce NF8 801 series supports work station and layout, which is Focus Type 1, through various shelves and partitions.



데스크 FDD80121 캐비닛 FSB80111D / FSB80111DD / FSB80109
서랍 FDB70031P 스크린 SSP50011FGY 의자 TOH55952

Type A

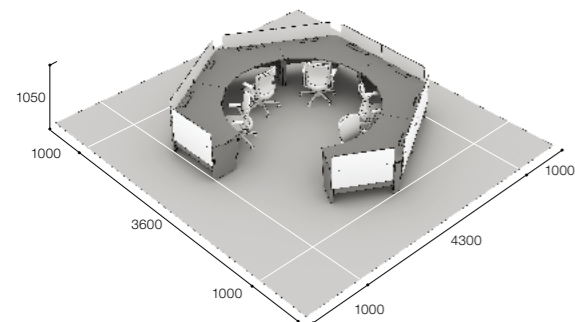

데스크	FDD80121MSW
이동서랍	FDB70030P
스크린	SSP50011FBU

Type B

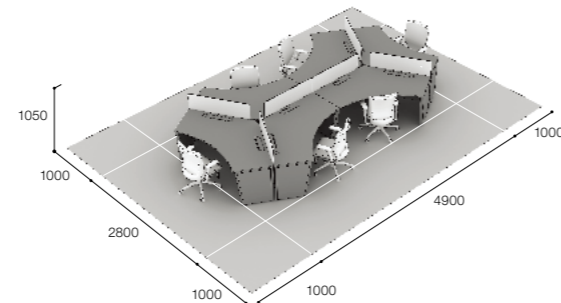

데스크	FDD80121MSW
이동서랍	FDB70030P
스크린	SSP50011FBU

임원공간 Executive space EX9

기업의 중요한 결정이 이루어지고 회의가 잦은 임원실은 별도 구획된 업무공간이 필요합니다. Neoce EX9 시리즈는 보안이 용이하며 다양한 회의 형태를 지원합니다. 또한 모던하고 세련된 디자인으로 트렌디한 중역실을 만들 수 있습니다.

The executive office where important decisions are made and meetings are frequent requires a separate workspace. The Neoce EX9 series is easy to secure and supports various conference types. You can also create trendy executive rooms with modern, sophisticated design.



책상 VDD90021D 서랍 VDB90004L 하부장 VRD90018R
캐비닛 VBS90008AG / VBS90006L / VOW90006R 크레덴자 VCR90016 의자 CSOH95052A

EX9 A

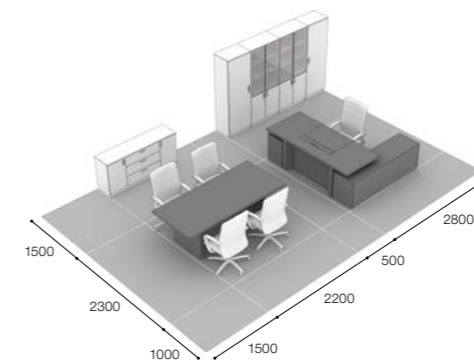

데스크	VDD90021D	하부장	VRD90018(L/R)
서랍	VDB90004(L/R)	크레덴자	VCR90016
회의테이블	VCT90022	캐비닛	VBS90008AG, VBS90006L, VOW90006R

EX9 A

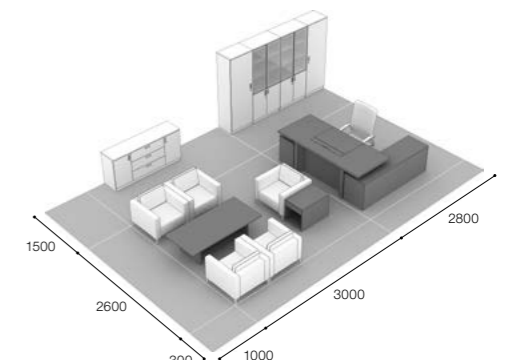

데스크	VDD90021D	하부장	VRD90018(L/R)
서랍	VDB90004(L/R)	크레덴자	VCR90016
회의테이블	SAO70110	캐비닛	VBS90008AG, VBS90006L, VOW90006R

Contents

리바트오피스 브랜드 방향성	2
Smart Office	10
Contents	14

Workplace

System

Easy Linker NEW	18
SF4 400 Group	28
NF9 900 Group	34
NF8 801, 800 Group	42
NF7 700 Group	50
ATHENA 3800Group	60
SPACE-PRO 5600Group	68

Panel

65T Partition	76
60T Partition	80
30T Partition NEW	86

Common

002 Group NEW	92
Accessories NEW	96

Executive

Veneer

KAISER 8100 Group	100
EX9 900 Group	106
EX8 800 Group	112
Laminate	
LACUS 6400 Group	118
EX3 301 Group	122
EX3 302 Group	126

Table

Conference

EC9 900 Group	132
HC7 700 Group	136
HC7 700 Group	140
HC5 500 Group (독립형)	144
HC5 500 Group (조합형)	148
Hub-T NEW	152
CT2000 Group	158

Seminar

SWING	160
CLECS	162
PC TABLE	164

Seating

Executive

8300G	170
S902G	172
S950G	174
S900G	176
6300G	178

Task

T558G	180
T500G	184
T559G	186
T554G	188
T503G	190
3600G	192
T501G	194
T553G	196
4300G	198
T555G	200
T302G	202
T353G	204
T557G	208

Multi-Use

400G	210
M151G	212
M100G	214
M152G	216
M153G	218
Seminar NEW	220
200G	221
350G	222
M253G	223
100G	224
M250G	225

Lobby

LH 5000 Group	226
LH 200 Group	227

Stool

CST6000G	228
M251G	229

Public

Amenity

C600 Group	232
RS2 201 Group	244
RS2 200 Group	246
RS1 100 Group	248
Archive NEW	254
Linkable NEW	256

Sofa

8100 Group	258
800 Group	258
RS7 700 Group	259
RS7 701 Group	259
7000 Group	260
3200 Group	260
RS3 300 Group	261
RS5 500 Group	261

Sofa Table

HC1 100 Group	262
HC2 200 Group	262
HC3 300 Group	263
C600 Group	263

Dormitory	264
-----------	-----

Library	268
---------	-----

Healthcare	270
------------	-----

Canteen	274
---------	-----

Hyundai Quming	278
----------------	-----

Business Area	282
---------------	-----

C/S & Contact Us	284
------------------	-----

Global Network	285
----------------	-----

Office Workplace

SYSTEM

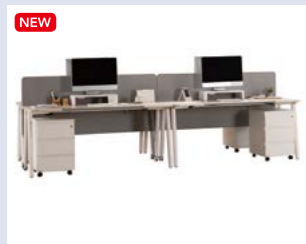

Easy Linker

18



SF4 400 Group

28



NF9 900 Group

34



NF8 801 / 800 Group

42

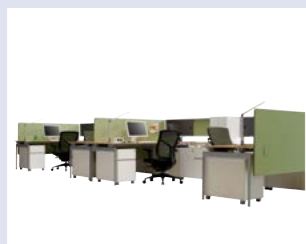

NF7 700 Group

50



ATHENA 3800 Group

60



SPACE-PRO 5600 Group

68

PANEL



65T Partition



76 60T Partition



80 30T Partition

86

COMMON



002 Group



92 Accessories

96

Easy Linker

Sensuous and Comfortable living office

편안하고 감각적인 리빙오피스

가정에서 일하듯 편안하고 따뜻한 사무공간의 새로운 트렌드.
간편한 조립성과 자유로운 레이아웃 구성으로 공간의 활용성을 극대화합니다.
개방적인 협업 업무 환경에 적합한 스마트 오피스를 제안합니다.
Warm and cozy new trend workplace felt like working at home.
Easy assembling and various layout maximize space utilization.
Suggests smart office for open and cooperative work environment.



Easy Linker Desk

독특한 다릿발과 차분한 컬러로 오피스 공간을 한층 부드럽게 만들어줍니다.

편리함과 깔끔함으로 사무공간의 효율성과 편안함을 동시에 선사합니다.

Unique legs and tone down color provides softer atmosphere to workplace.

Suggests efficient utilization and comfort at the same time by simple and convenient design.



데스크 SDD50016UD 하부장 SSB50012(L/R)
스크린 SSP50016F 의자 TOH50352L



데스크 SDD50016UD 상부장 SSU50008 서랍 FDB70020P
스크린 SSP50016F 의자 TOH50332L



- 1 펜트레이와 일반 덮개로 활용이 용이한 전선덕트 커버
- 2 다릿발의 부품을 제거하여 전선으로 지지분한 하부를 깔끔하게 정리하는 다릿발 매립형 전선덕트
- 3 책상 연결사용 및 책상 수평 조절에 용이한 다릿발 레벨러로 수평 높이 조절이 가능합니다.
- 4 팔이 닿는 면에 부드러운 소재 적용한 우레탄 패드

- 1 Efficient duct cover with pen tray and general cover.
- 2 Leg embeded duct manages lower part wire.
- 3 Leg leveler for horizontal control.
- 4 Soft urethane pad for soft touching.

Easy Linker Optional Items

작업의 효율성과 수납성을 높이는 다양한 아이템으로
업무의 능률과 창의성이 높아집니다.

Enhances worker's creativity and efficiency with various item
providing better storage and efficient.



데스크 SDD50016UD 상부장 SSU50008 하부장 SSB50012(L/R)
스크린 SSP50016F 의자 TOH50332L



- 1 마그네틱 핀업 가능한 걸면과 슬라이딩 도어로 수납력을 높인 내부로 구성된 철재 상부장
- 2 상부 손잡이로 이동이 편리하며 수납함, PC본체 수납장으로 구성된 모바일 하부장(바퀴 고정 가능)
- 3 3단계 높이조절이 가능하며 전면 휴대폰 거치대, 후면 펜트레이가 적용된 모니터 받침대
- 4 경량화 스크린으로 탈부착이 편하고 마그네틱 부착이 가능합니다.

- 1 Steel upper cabinet provides better storage with sliding door and magnetic pin up function.
- 2 Mobile below cabinet includes PC cabinet and storage with upper handle.(caster fixing function)
- 3 3 levels height adjustable cradle for smart phone and monitor with pan tray.
- 4 Screen with easy attachment for magnetic.

Easy Linker ^{NEW} Movable Desk/Cable Management

업무환경의 변화로 개인 작업공간은 작아지고 공용환경은 넓어지면서 다양한 종류의 오피스 아이템들이 필요해졌습니다. 넓은 크기와 깊이의 데스크와 설치가 쉬운 매니지먼트 아이템들은 유연한 레이아웃 배치가 가능하도록 해줍니다.

As the work environment changes, personal workspaces become smaller and public workspaces become larger, and various kinds of office furniture and equipment are required. Wide depth of the desk and easy-to-install management items allows for flexible layout placement.



(좌측 세트) 데스크 우레탄형 H010792 서랍 H010358 의자 TOH55852LWDG 스크린 H010796
(우측 세트) 데스크 H010454 서랍 H010359 의자 MOH15391 스크린 H010797



- 1 데스크 전면 다리는 캐스터로 이동이 편리합니다.
- 2 캐스터는 잠금 기능으로 고정 가능합니다.
- 3 팀장석은 배선형 스크린에 달려있는 캡을 통하여 배선이 가능합니다.

1. Casters mounted to the front legs of the desk allow the users to move it easily and freely change the layout.
2. Casters mounted to the front legs of the desk provide easy gliding motion and prevent scratches on the floor. Also the caster wheel can be fixed by locking function.
3. When wiring for manager's desk, you can wire through wiring hole cap next to the screen bracket

이지링커 배선 원리 Easy Linker Wiring Principle



— 케이블 Cable - - - 비활성 케이블 Inactive Cable

케이블의 색상으로 구분하여 알맞은 곳을 연결하세요.

최대 네 개의 데스크 연결까지 가능합니다. (데스크 한 개는 별도 배선 필요)

Connect the proper places by distinguishing the colors of the cables.

Up to four desk connections are possible. (One desk requires separate wiring)

이지링커 활용 레이아웃 Easy Linker Utilization Layout

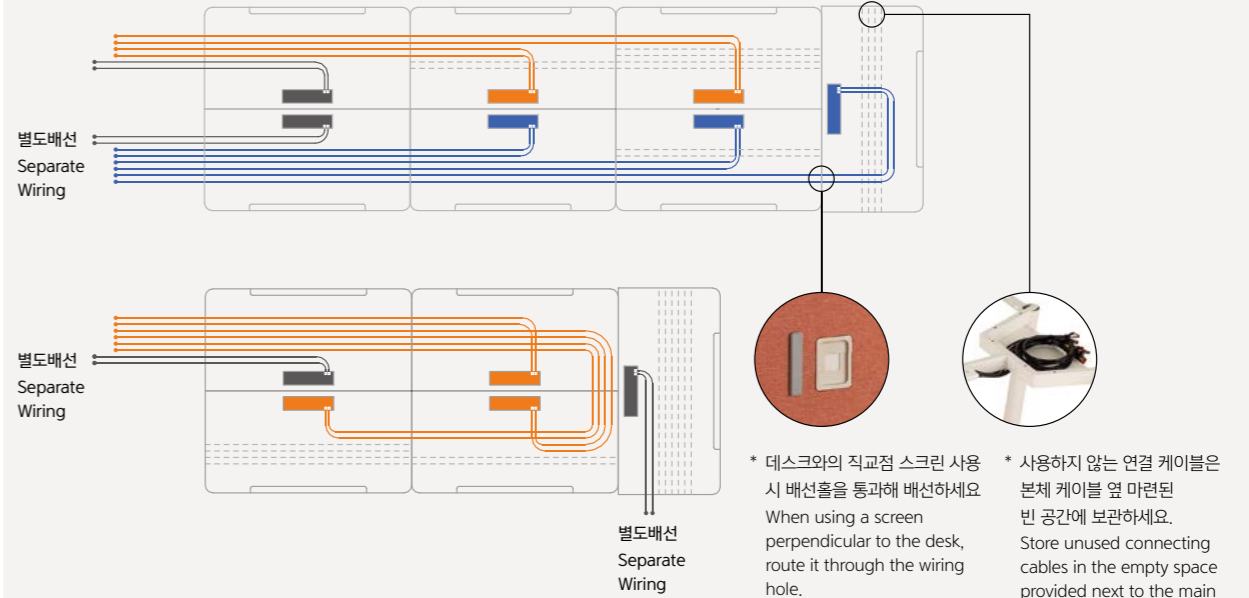

* 데스크와의 직교점 스크린 사용 시 배선홀을 통과해 배선하세요
When using a screen perpendicular to the desk, route it through the wiring hole.

* 사용하지 않는 연결 케이블은 본체 케이블 옆 마련된 빈 공간에 보관하세요.
Store unused connecting cables in the empty space provided next to the main body cable.



- 1 케이블 매니지먼트는 이지링커 제품에 별도 판매상품이며, 이미지처럼 깔끔한 배선정리가 가능합니다.
- 2 케이블을 단자 컬러에 맞게 연결하며, 측면 30T 파티션 사용시 배선통로형을 사용합니다.
- 3 최대 4대 책상 연결이 가능하며, 랜선은 전화선으로도 이용 가능합니다.

- 1 Cable management is sold separately to the "Easy Linker", and neat wiring arrangement is possible as shown in the picture.
- 2 It is possible to connect the cable according to the color of the terminal, and use the wiring passage type while using the side 30T partition
- 3 It is possible to connect the four desks in a row in maximum, and LAN lines are also available through the telephone line.

Desk / Storage 데스크 / 스토리지

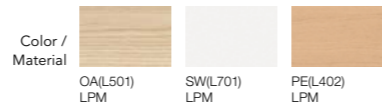

일반형 Standard Desk
 SSD50014DN 1400 · 790 · 730
 SDD50016DN 1600 · 790 · 730
 H010788 ~ 90 1800 · 790 · 730

Color, OA / SW / PE



우레탄형 Urethane Edge Type
 SSD50014UDN 1400 · 790 · 730
 SDD50016UDN 1600 · 790 · 730
 H010791 ~ 93 1800 · 790 · 730

Color, OA / SW / PE



상부장 Upper Part Storage
 SSU50008 785 · 350 · 496

Color, SW



SSB50011R

하부장 Lower Part Storage
 SSB50011(L/R) 1100 · 400 · 655

Color, SW

Movable Desk 무버블 데스크

* 다릿발 보강파이프, 다릿발 별도 품목 제외

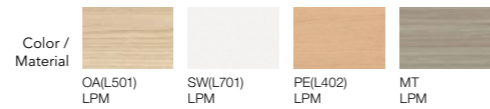

무버블 데스크 Movable Desk
 H010443 ~ 46 1400 · 790 · 730
 H010447 ~ 50 1600 · 790 · 730
 H010451 ~ 54 1800 · 790 · 730

Color, OA / SW / PE / MT



무버블 데스크 우레탄형 Movable Desk(Urethane Type)
 H010455 ~ 58 1400 · 790 · 730
 H010459 ~ 62 1600 · 790 · 730
 H010463 ~ 66 1800 · 790 · 730

Color, OA / SW / PE / MT



무버블 데스크 케이블 매니지먼트 Desk Cable Management
 H010419

Color, SW

Common Drawers 공용서랍

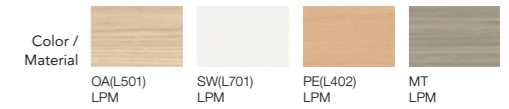

이동식 서랍박스 (3단, 확장형) Movable Drawer (3-Level, Extended Type)
 H011791(PE) 400 · 500 · 606
 H011792(SW) 400 · 500 · 606
 H010356(MT) 400 · 500 · 606
 H011871(OA) 400 · 500 · 606

Color, OA / SW / PE / MT



이동식 서랍박스 (3단) Movable Drawer (3-Level)
 H007056(PE) 400 · 500 · 606
 H007057(SW) 400 · 500 · 606
 H010358(MT) 400 · 500 · 606
 H011872(OA) 400 · 500 · 606

Color, OA / SW / PE / MT



이동식 서랍박스 (2단) Movable Drawer (2-Level)
 H007054(PE) 400 · 500 · 606
 H007055(SW) 400 · 500 · 606
 H010356(MT) 400 · 500 · 606
 H011871(OA) 400 · 500 · 606

Color, OA / SW / PE / MT

Screen Partition 스크린파티션

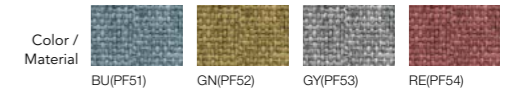

데스크 스크린(패브릭) Desk Privacy Screen(Fabric)
전면 낮은 스크린 Front Low Type
 SSP50014F 1398 · 12 · 700
 SSP50016F 1598 · 12 · 700
 H010794 ~ 97 1800 · 12 · 700
전면 높은 스크린 Front Tall Type
 SSP50014FH 1398 · 12 · 850
 SSP50016FH 1598 · 12 · 850
 H010798 ~ 801 1800 · 12 · 850

*SF4 호환가능 (compatible with SF4)
 Color, BU / GN / GY / RE

측면 낮은 스크린 Side Low Type
 SSP50008F 798 · 12 · 700
측면 높은 스크린 Side Tall Type
 SSP50008FH 798 · 12 · 850

Color, BU / GN / GY / RE



배선형 스크린 Desk Privacy Screen for Wiring
전면 높은 스크린 Front Tall Type
 H010394 ~ 97 1400 · 12 · 850
 H010402 ~ 05 1600 · 12 · 850
 H010410 ~ 13 1800 · 12 · 850

Color, BU / GN / GY / RE

전면 낮은 스크린 Front Low Type
 H010398 ~ 401 1400 · 12 · 750
 H010406 ~ 09 1600 · 12 · 750
 H010414 ~ 17 1800 · 12 · 750

Color, BU / GN / GY / RE



전선정리용 클립 Clip for wiring, wired screen
 FLC1000

* 스크린 클립브라켓 대체 사용
 Color, SW

SF4 400 Group

Best solution for cooperation
and communication work environment

협업과 소통이 중요한 업무 환경에 적합한 최적의 솔루션

개방적인 분위기 연출, 자유로운 소통이 가능한 워킹라운지를 제안합니다.

다양하고 트렌디한 구성품으로 다채로운 공간구성이 가능합니다.

Suggests open atmosphere and easy communication workplace.

Space organization is available with mobility and clean construction.



SF4 400 Group Desk

두가지 타입의 다리를 선택할 수 있어 다양한 형태의 워크 스테이션 구성이 가능한 SF4.
스마트 오피스에 걸맞은 스마트한 가구입니다.

SF4 provides various workstation construction with 2 leg options.
Intelligent office furniture for smart office environment.



데스크 SDD40016HD 서랍 FDB70020NP 소파 SSFO40003 스크린 SSP50018F / SSP40008F 의자 TOH50332L



- 1 후면을 필기구 정리함으로 활용할 수 있는 기능성 전선덕트 커버
- 2 책상 연결사용 및 책상 수평 조절에 용이한 다릿발 레벨러로 수평 높이 조절이 가능합니다.
- 3 모듈구성시 간격을 최소화한 책상디자인으로 공간 활용성이 높습니다.
- 4 액세서리 및 마그네틱을 부착할 수 있는 스틸패널(High Leg 책상 전용)
- 5 정돈이 어려운 여러 배선들을 정리하는 수직덕트.

- 1 Functional wire duct cover facilitates arranging writing tools.
- 2 Leg leveler provides horizontal control function.
- 3 Constituting with module provides better space utility.
- 4 Steel panel is attachable for magnetic and accessory.
- 5 Leg embedded duct manages lower part wire.

SF4 400 Group Optional Items

다양한 업무형태를 고려한 다채로운 구성품으로 업무환경을 더욱 스마트하게 구성할 수 있습니다.

Diverse components considering various work environment provides smarter work condition.



데스크 SDD40016LD / SDD40016HD 서랍 FDB70020P 데스크선반 SDBS40010
소파 SSFO40003 의자 TOH50352L / TOH50332L



- 1 스틸철판에 패브릭 마감되어 마그네틱 부착이 가능한 패브릭 사이드 스크린
- 2 서적과 악세서리 거치, 마그네틱 부착이 가능하며 대면형으로 사용할 수 있는 데스크 선반
- 3 서적과 화분 등 소품 보관 가능한 사이드 선반

SF4 400 Group

Desk / Accessories 데스크 / 액세서리

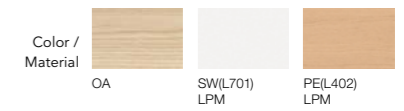

낮은 다리형 책상 Low Leg
SSD40014LD 1400 · 790 · 730
SDD40016LD 1600 · 790 · 730
H010990 ~ 92 1800 · 790 · 730

Color: OA / SW / PE



높은 다리형 책상 High Leg
SSD40014HD 1400 · 790 · 900
SDD40016HD 1600 · 790 · 900
H010993 ~ 95 1800 · 790 · 900

Color: OA / SW / PE



데스크 선반 Desk Shelf
SDBS40010 1002 · 302 · 386

Color: SW



사이드 선반 Side Shelf
SS40002 220 · 550 · 18

Color: SW



수직덕트 Vertical Duct
SDT40000

Screen Partition 스크린파티션

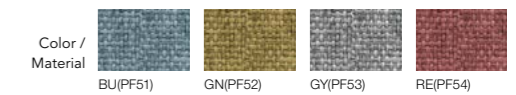

사이드 스크린(패브릭) Side Screen(Fabric)
SSP40008F 788 · 12 · 700

Color: BU / GN / GY / RE



사이드 스크린(아크릴) Side Screen(Acrylic)
SSP40008SG 800 · 5 · 760

Sofa 소파



2인 소파 Sofa
SSFO40003 1600 · 739 · 730

Color: GY / MU

NF9 900 Group

Bench type desk for communication type office

소통형 오피스를 위한 벤치형 데스크

구성원 간의 원활한 소통을 위해 팀원 사이의 공간구획을 최소화하고 이동이 가능한 하부장, 전동식 회의테이블을 배치하여 원활한 커뮤니케이션이 가능합니다.

It enables smooth communication by minimizing space area among team members and placing base and electronic meeting table, which is possible to move around.



NF9 900 Group Height-Adjustable Desk

활동적이고 건강한 사무환경을 만들기 위해 높이 조절 데스크를 제안합니다.

사용자의 건강과 업무형태까지 고려한 다양한 높이 조절형 아이템으로 오피스의 분위기를 바꿔보세요.

We suggest height adjustment desk to create active and healthy office environment. Change the mood of your office with a variety of height-adjustable items that take into account your health and work style.

스탠딩 워크가 왜 필요할까요? Why do you need a standing work?

우리가 서있을 때는 디스크에 가해지는 힘은 체중의 약 1.5배, 앉아있을 때는 약 2배, 앉은 자세에서 구부정하면 약 2.5배의 무게가 디스크에 가해지게 되며 오랫동안 앉아서 일을 하게 되면 디스크 영양분과 산소 공급이 어려워져 척추 퇴행성 변화도 빨리 나타날 수 있습니다.

앉아 있을 때는 일자목, 거북목 증후군이 많이 발생하게 됩니다. 1cm 정도 목이 앞으로 빠지면 목과 어깨에 3kg에 해당하는 무게가 가해지게 되어 거북목 증후군과 같은 척추 변형이 일어납니다. 디스크나 협착증 같은 퇴행성 질환이 올 수 있고 신경이 눌리기 때문에 다리가 저릴 수 있습니다.

When we stand, the force on the disc is about 1.5 times the weight of the body, about twice the weight when sitting, and the weight of about 2.5 times and is applied to the disk when you are bent in a sitting position. Sitting for long periods of time can make disc nutrients and oxygen supply more difficult, leading to faster spinal degenerative changes.

When sitting, there is a lot of forward head posture, turtle neck syndrome. When the neck is about 1 cm forward, 3 kg of weight is applied to the neck and shoulders, resulting in spinal deformity such as turtle neck syndrome. Degenerative diseases, such as discs or stenosis, can come, and the nerves can be pressed, causing your legs to numb.

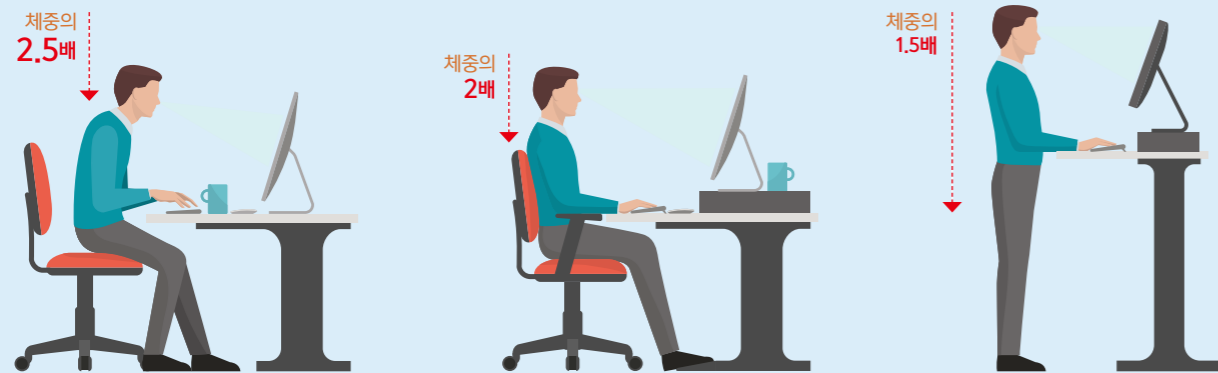

이상적인 스탠딩 워크 시간 Ideal Standing Work Time

스탠딩 워크는 사람에 따라 하체 근력 상태에 따라 시간의 비율을 다르게 하는 것이 좋습니다. 처음에는 무리하지 말고 2시간부터 시작해 서서히 시간을 늘리는 것이 좋습니다. 비율은 반은 서있고 반은 앉아서 일을 하는 것이 좋으며, 개인의 컨디션에 따라 적당한 비율을 조절하는 것이 좋습니다. 서서 일하면 앉아있을 때보다 움직임이 자유로워져 활동량이 많아지게 되고, 이로 인해 성인질환 예방 및 근력 강화에도 도움이 될 수 있습니다.

Standing Work Time is recommended to vary the percentage of time depending on the person's lower body strength. Do not overdo it at first, but start with 2 hours and gradually increase the time. It is better to have half standing, half sitting and working, and adjust the reasonable ratio according to your condition. Standing and working gives you more freedom of movement than sitting, which can help you prevent adult illness and strengthen your muscle strength.

올바른 스탠딩 워크 자세 Correct standing work position

- ① 다리를 어깨너비만큼 벌려주고 발끝은 바깥쪽을 향하게 살짝 돌려줍니다.
- ② 어깨선과 골반이 일직선이 되도록 서주세요.
- ③ 책상 위에 팔을 올렸을 때 팔꿈치가 90도가 되도록 만들어주세요.
- ④ 중간중간 스트레칭을 하면 보다 건강하게 스탠딩 워크를 즐길 수 있습니다.

- ① Spread your legs shoulder-width apart, and turn your toes slightly outward.
- ② Stand with your shoulders and pelvis in a straight line.
- ③ Make sure your elbows are at 90 degrees when you place your arms on the desk.
- ④ You can enjoy standing work healthier if you stretch in the middle.

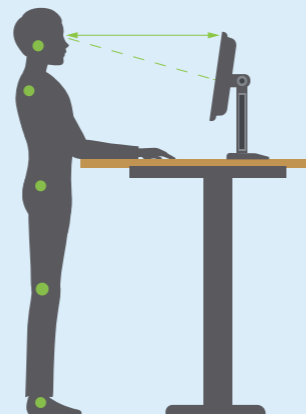

- 1 UP/DOWN 버튼을 통해 개인의 체형과 업무 환경에 따른 최저 630mm에서 최대 1280mm까지 맞춤형 조절이 가능합니다.
- 2 알루미늄 양문형 덕트 콘센트는 랜포트, USB 2port, 4구 콘센트 사용이 가능합니다. (옵션 항목 : 블랙, 화이트)
- 3 최고급 사양의 모터를 사용하여 유격 없이 부드럽게 사용할 수 있습니다.
- 4 다양한 업무 형태와 용도에 따라 선택이 가능한 높낮이 조절형 제품입니다.
- 5 독립데스크의 움직임에 영향을 받지 않는 독립형 하부장이 있어 안정감이 있습니다.
- 6 사이드장에 볼캐스터를 부착하여 이동이 자유롭고 다양한 배치가 가능하도록 하였습니다.

- 1 The UP/DOWN button allows you to customize the scale from 630mm up to 1,280mm, depending on your body type and work environment.
- 2 This aluminum double-door duct socket-outlets are available with LAN port, USB 2 port, and 4 sockets-outlet (option : black, white)
- 3 The highest-grade motors allow smooth operation without play.
- 4 It is a height-adjustable product that can be selected according to various work forms and uses.
- 5 There is an independent lower cabinet that is not affected by the movement of the independent desk, so there is a sense of stability.
- 6 A ball caster is attached to the side cabinet for free movement and various arrangements.

NF9 900 Group Independent System

이동이 용이하고 1인 구성이 가능한 독립형 시스템은 전동식 익스텐션을 선택하여 소통형 오피스 구현이 가능합니다. Stand-alone system that is easy to move and can be configured as one person can implement communication type office by selecting electric extension.



- 1 책상 다릿발에 레벨러가 부착되어 책상 연결사용 및 책상 수평 조절에 도움을 줍니다.
- 2 4개의 높이를 기억하는 메모리버튼이 있는 LCD DISPLAY 방식의 높이조절 스위치
- 3 높낮이 보조테이블로 탄력적인 회의분위기가 조성됩니다. 또한 디스플레이 되는 컨트롤러로 자신에게 맞는 높이 조절로 입력이 되어 편하게 조절 가능합니다.

1 A leveler is attached to the desk leg, which helps desk connection and desk leveling.
2 LCD DISPLAY method height adjustable switch with memory button memorizing 4 levels of height.
3 An elevation ancillary table creates a resilient meeting atmosphere. Also, it can be adjusted easily by inputting the height control which is suitable for yourself with the controller to be displayed.

NF9 900 Group Bench System - Bench Desk

벤치형 데스크는 간결한 구조로 공간의 낭비 없이 효율적인 공간 구성이 가능합니다. 완벽한 배선 솔루션과 전동식 회의테이블은 스마트한 사무환경을 완성합니다. Bench-type desk is simple structure and efficient space configuration is possible without waste of space. Complete wiring solution and electric conference table complete smart office environment.



- 1 높낮이 기능의 회의 테이블은 활동적인 회의 분위기를 조성하며, 스탠딩 회의가 가능하여 효율적인 소통이 이뤄집니다.
- 2 책상 상부에 180도 개폐형 배선 덕트로 OA, 스마트 기기의 사용이 편리하며 깔끔하게 정리할 수 있습니다.
- 3 간단한 자석 탈부착의 배선 수납 공간으로 배선을 쉽게 정리할 수 있습니다.

1 The conference table with the elevation function creates an active meeting atmosphere and enables efficient communication by enabling standing meetings.
2 With 180 degree opening and closing type wiring duct on the upper part of the desk, it is easy to use OA and smart device, which can be neatly organized.
3 Wiring can be easily arranged with simple magnet detachable wiring compartment space.

Desk 데스크

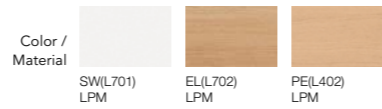

전동데스크 Height-adjustable Desk
일반형 General Type
 FDD90014 1394 · 794 · 630~1280
 FDD90016 1594 · 794 · 630~1280
덕트형 Duct Type
 FDD90014D 1394 · 794 · 630~1280
 FDD90016D 1594 · 794 · 630~1280

Color. SW / EL



전동데스크 Height-adjustable Desk
일반형 General Type
 FPD90006 594 · 544 · 620~1280
 FPD90008 794 · 544 · 620~1280

Color. SW / EL



전동데스크 Height-adjustable Desk
회의테이블 Conference Table
 FCT90016UD 1600 · 1200 · 720~1220
 덕트 포함 Include Duct

Color. SW / PE



전동데스크 Height-adjustable Desk
익스텐션 Extension
 FPD90006UD 600 · 1200 · 720~1220

Color. SW / PE



2인 모듈책상 Double Type Desk
덕트형 Duct Type
 FBD900142D 1400 · 1599 · 730
 FBD900162D 1600 · 1599 · 730
 FBD900182D 1800 · 1599 · 730

Color. SW / PE



독립형 책상 Independent Desk
덕트형 Duct Type
 FDD90016ND 1600 · 750 · 730

Color. SW / PE



다릿발 마감패널
Bottom of Panel to Cover the Legs
 FPN9001 111 · 650 · 7.5

Color. SW

Storage 스토리지



하부장 Lower Cabinet
 FSB90010C(L/R) 980 · 501 · 632

Color. SW

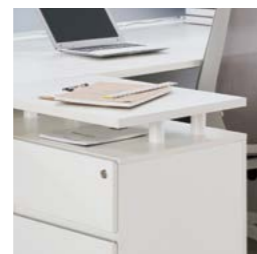

보조상판 Extension Worktop
 FRT90006 580 · 348 · 98
 FSB70008와 연결
 Connect with FSB70008

Color. SW / PE

Screen Partition 스크린파티션



데스크 스크린(패브릭)
Desk Privacy Screen(Fabric)

전면 전체 가림 Blocks Front
 FSP90006F 594 · 18 · 832

Color. GY / LB / OR / GN / BU / RE



데스크 스크린(패브릭)
Desk Privacy Screen(Fabric)

전면 전체 가림 Blocks Front
 FSP90016F 1600 · 18 · 832

Color. GY / LB / OR / GN / BU / RE



데스크 스크린(아크릴)
Desk Privacy Screen(Acrylic)

전면 전체 가림 Blocks Front
 FSP90016G 1600 · 8 · 760



상부 데스크 스크린(패브릭)
Upper Desk Privacy Screen(Fabric)

일반 스크린 Standard Screen
 FSP90014AF 1360 · 9 · 282
 FSP90016AF 1560 · 9 · 282

자석 스크린 Magnet Screen
 FSP90014MAF 1360 · 6 · 282
 FSP90016MAF 1560 · 6 · 282
 FSP90018MAF 1760 · 6 · 282

Color. GY / LB / OR / GN / BU / RE



상부 데스크 스크린(아크릴)
Upper Desk Privacy Screen(Acrylic)

일반 스크린 Standard Screen
 FSP90014AG 1360 · 4 · 282
 FSP90016AG 1560 · 4 · 282
 FSP90018AG 1760 · 4 · 282

NF8 801 Group

New 120-degree module type desk

새로운 120도 모듈형 데스크

구성원 간 원활한 커뮤니케이션에 적합한 레이아웃 구성은 업무 능력을 향상시켜줍니다. 트렌디한 디자인과 공간에 맞는 다양한 컬러 조합으로 다채로운 공간 구성이 가능합니다. Layout configuration for smooth communication between members improves work ability. Trendy design and a combination of various colors for the space enable colorful space composition.



NF8 801Group 120-degree module desk

팀워크를 통한 리더십과 팀 스피릿을 높여주기 위해 동심원 레이아웃을 통한 업무환경을 추천합니다.
서로 대화하고 함께 일할 수 있는 환경을 만들어주는 3가지 타입을 제안합니다.

We recommend work environment through concentric layout to enhance leadership and team spirit through teamwork.
We suggest three types that create an environment where members can communicate with each other and work together.

TYPE 1. C Type

팀원소통이 가장 좋은 C 타입은 중앙부에 팀원이 배속되어 업무협약에 매우 원활한 업무환경을 만들어 줍니다. 레이아웃 환경에 맞는 캐비닛을 사용하면 많은 수납 공간을 활용할 수 있습니다

Type C is made for the best communication within team members, and it creates a working environment suitable for interactive business consultation by placing team members in the center.



데스크 FDD80121 캐비닛 FSB80111D / FSB80111DD / FSB80109
서랍 FDB70031P 스크린 SSP50011FGY 의자 TOH55952

TYPE 2. X Type

C 타입은 여유공간이 많이 필요한 편이지만 X 타입은 작은 공간에서도 효율적이며 큰 X 타입과 작은 X 타입으로 다양한 레이아웃 연출이 가능합니다.

C type requires a lot of free space, but X type is efficient even in a small space, and large X type and small X type can create various layouts.



데스크 FDD80121 서랍 FDB70031P
스크린 SSP50011FGY 의자 TOH55952

TYPE 3. Y Type

가장 많은 업무공간에서 사용되는 일반적인 일자형 구조에 응용하기 좋으며, 중앙에 팀장석과 좌우 파트장석 구성하면 소통에 효율적인 레이아웃으로 연출이 가능합니다.

It is applicable for general linear structure used in the most work spaces, and if you put the team manager's desk in the center with head of partners' desks in the left and right, you can create a communication-efficient layout.



데스크 FDD80121 / FDD80116 서랍 FDB70031P
스크린 SSP50011FGY 의자 TOH55952



- 1 다릿발 배선은 마감패널의 마그네틱 연결로 쉽게 탈 부착하여 배선처리가 용이합니다.
- 2 120도 책상을 원형으로 배치 후 스크린 중앙부에 마감패널 코너형 연결하여 배선기능 및 깔끔한 외관을 만들어 줍니다.
- 3 캐비닛 안에 이동형 캐비닛을 위치시키거나 다른 곳으로 이동시킬 수 있어 다양하게 활용할 수 있습니다.
- 4 120도 데스크의 경우 중앙 다릿발을 활용해 배선처리로 활용할 수 있습니다.
- 5 덕트 내 멀티탭 매립사양을 선택할 수 있습니다.

- 1 Wiring is easy because pier wiring can be easily attached and detached by magnetic connection of finish panel.
- 2 Place a 120-degree desk in a circular shape, and then connect them to the corner of the finish panel in the center of the screen to perform wiring and create a neat look.
- 3 You can use the cabinets for various purposes by locating movable cabinets in cabinets or moving them to other places.
- 4 For 120-degree desk, you can use it for as wiring by utilizing the central pier.
- 5 You can select the multi-tab embedment specification in the duct.

Desk 데스크

Color / Material
SW(L701)
LPM



120도 데스크 120-Degree Desk
FDD80121SW 2120 · 1216 · 730
FDD80121MSW 2120 · 1216 · 730
(무선충전용)

* 사이드가림판 별도 exclude side panel
Color. SW



일반 데스크 Standard Desk
FDD80114SW 1400 · 720 · 730
FDD80116SW 1600 · 720 · 730
FDD80114MSW 1400 · 720 · 730
FDD80116MSW 1600 · 720 · 730
(무선충전용)

* 사이드가림판 별도 exclude side panel
Color. SW



코너마감 책상 Corner Desk
FDD80112CL(R) SW 1184 · 720 · 730

* 사이드가림판 별도 exclude side panel
Color. SW



사이드가림판 Side Panel(Wire Type)
FPN8011N(L/R) 535 · 655 · 10

Color. SW

Storage 스토리지

Color / Material
SW(L701)
LPM



캐비닛 도어형 세트
Cabinet Door Type Set
FSB80111D 1100 · 720 · 730

Color. SW



캐비닛 서랍형 세트
Cabinet Door Type Set
FSB80111DD 1100 · 720 · 730

Color. SW



캐비닛 도어형
Cabinet Door Type
FSR80111D 1100 · 720 · 730

Color. SW



캐비닛 서랍형
Cabinet Drawer Type
FSR80111DD 1100 · 720 · 730

Color. SW



이동형캐비닛
Movable Cabinet
FBS80106 666 · 704 · 380

Color. SW



코너형 캐비닛
Corner Cabinet
FSB80109C 950 · 835 · 730

Color. SW

Screen Partition 스크린파티션

Color / Material
SW(L701) LPM
PF64 DARK GRAY
PF70 GREEN
PF71 BLUE
PF72 RED



일자형 코너 철재스크린
Linear-corner Steel Screen
SSP80128SL 281 · 32 · 280
SSP80128SH 281 · 32 · 430

Color. SW



삼각형 코너 철재스크린
Triangle-corner Steel Screen
SSP80128TL 281 · 234 · 280
SSP80128TH 281 · 234 · 430

Color. SW



120도 데스크 전면스크린 120-Degree Desk Front Screen
낮은스크린 Low Type
SSP50011F 1098 · 12 · 700
*NF8 801G 120도 데스크 전용 (For NF8 801G 120 degree desk)

높은스크린 Tall Type
SSP50011H 1098 · 12 · 850
*NF8 801G 전용 (For NF8 801G 120 degree desk)

Color. BU / GN / GY / RE

일자형 데스크 스크린은 SF5 500 Group, SF4 400 Group과 공통 스크린을 적용합니다.

NF8 800 Group Desk

1인 워크스테이션 구성이 가능한 벤치형 데스크는 이동이 용이하고 다양한 레이아웃이 가능합니다.

Bench-type desk with 1-man workstation configuration makes it easy to move and allows various layouts.



데스크 FSD80014D 스크린 FSP90014AG



- 1 벤치형태의 자리 배치뿐만 아니라, 1인석만으로도 설치가 가능합니다.
- 2 멀티콘센트 부분 상판을 곡선으로 마감하여 각이 있는 상판에 부드러움을 더했습니다.
- 3 복잡한 멀티탭 연결선 정리가 가능한 다릿발 패널은 하부공간을 깔끔하게 가려주며 프라이버시 또한 보호해 줍니다.

- 1 It is possible to install it with a single seat as well as a bench type seat arrangement.
- 2 The top plate of multi-outlet section is finished with curved lines, adding softness to the top plate with angles.
- 3 The legged panel, which allows complex multi-tap connections, keeps the bottom space neat and protects privacy.

NF8 800 Group

Desk 데스크

Color / Material	SW(L701) LPM	PE(L402) LPM



일반 데스크 Standard Desk
 FSD80014D 1400 · 800 · 730
 FDD80016D 1600 · 800 · 730
 FDD80018D 1800 · 800 · 730
 덕트 포함 Include Duct



사이드가림판(전선통과형) Side Panel(Wire Type)
 FPN8001(L/R) 735 · 651 · 10

사이드가림판(마감형) Side Panel(Finished Type)
 FPN8002(L/R) 735 · 651 · 10

* 사이드가림판 별도 exclude side panel
 Color. SW / PE

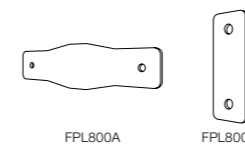

연결평철 Connecting Bracket
연결평철A Connecting Bracket A
 FPL800A
 압출빔가로체결용
 Extruded parts for horizontal fixing

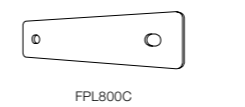

연결평철B Connecting Bracket B
 FPL800B
 압출빔세로체결용
 Extruded parts for vertical fixing

연결평철C Connecting Bracket C
 FPL800C
 책상상판체결용
 Parts for fixing top panel of the desk

연결평철 세트 Connecting Bracket Set
 2인세트A(일면형) FPL8002A
 2 Person Set A(Single Type)
 3인세트A(일면형) FPL8003A
 3 Person Set A(Single Type)
 4인세트B(대면형) FPL8004B
 4 Person Set B(Double Type)
 6인세트B(대면형) FPL8006B
 6 Person Set B(Double Type)

Screen Partition 스크린파티션

Color / Material	PF64 DARK GRAY	PF65 LIGHT BLUE	PF69 ORANGE	PF70 GREEN	PF71 BLUE	PF72 RED



데스크 스크린(패브릭) Desk Privacy Screen(Fabric)
 FSP80008FS 800 · 18 · 1023
 FSP80016FS 1600 · 18 · 1023

Color. GY / LB / OR / GN / BU / RE

NF7 700 Group

많은 인원이 함께 일하는 지원직군, 다양한 수납공간이 필요한 연구직군 등 모든 타입의 사무환경을 구성 할 수 있습니다.

It is possible to create all types of office environment such as research group which requires a lot of storage space and support group in which many members work together as a team.

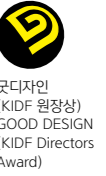

NF7 700 Group Interface

NF7의 다양한 기능들로 사용자가 원하는 사무환경을 구성할 수 있습니다.
It can create office environment that the user wants through various NF7 functions.



- 1 책상다리는 높이를 조절할 수 있는 레벨러를 부착하였습니다.
- 2 책상 상판에 부착할 수 있는 멀티탭 커넥터.(FMT 700~)
- 3 알루미늄 양문형 덕트 콘센트는 랜포트, USB 2port, 4구 콘센트 사용이 가능합니다. (옵션 항목 : 블랙, 화이트)
- 4 PC 본체의 수납 및 사용이 쉽도록 설계되었으며, 안쪽에 멀티탭이 있어 전선 정리 및 인출이 편리합니다.
- 5 또 하나의 배선기능으로 Under-line 배선을 가능케 합니다.
- 6 PC장의 상판에는 PC에서 나오는 열을 발산시키도록 벤트 공기구멍을 설치하였습니다.

- 1 Leveler for adjusting desk height.
- 2 Multiple tap connector that can be attached on the desk surface. (FMT 700~)
- 3 This aluminum double-door duct socket-outlets are available with LAN port, USB 2 port, and 4 sockets-outlet (option : black, white)
- 4 Designed to make PC storage and use much easier and ensure that cables are arranged neatly and used comfortably with a multi-tab installed inside.
- 5 Additional space for organizing cables under the desk.
- 6 Ventilation outlet on top of the PC cabinet ensures no overheating of the computer.

NF7 700 Group Storage

사용자의 니즈를 충족시킬 수 있는 다양한 품목의 수납장으로
맞은 워크스테이션을 구성할 수 있습니다.
It can create proper work station through shelf with various
product types that can satisfy need of users.



- 1 편리성과 보안성이 높은 터치식 디지털 락 시스템을 적용할 수 있습니다.
(서랍전면 사출사양 Only)
- 2 사출서랍박스의 탈부착 펜트레이는 다양한 기능으로 활용할 수 있습니다.
(서랍전면 사출사양 Only)
- 3 각종 서류를 효율적으로 보관할 수 있는 서류장. 용량이 커서
다량의 서류를 보관할 수 있으며 개폐가 부드럽습니다.
- 4 각종 문구류나 소품, 모바일 기기 등을 효율적으로 보관할 수 있는
서랍 트레이.
- 5 옷장도어의 내장형 손잡이는 사이드장과 동일한 디자인으로 깔끔하고
심플합니다.
- 6 사이드장과 함께 배치되어 사용이 편리하며 거울, 소품 보관함 등
다양한 액세서리를 갖춘 옷장.

- 1 Digital lock system with more focus on security by using an easily
accessible touch keypad. (Only for drawers with injection
moulding-based fronts)
- 2 The multi-purpose usability of easily attachable pan trays of drawer
boxes. (Only for drawers with injection moulding-based fronts)
- 3 Document cabinet offers large storage capacity and smooth
opening /closing of doors.
- 4 Drawer trays for efficient organization of stationeries, accessories
and mobile devices.
- 5 Simple and tidy with embedded handles and a uniformed design.
- 6 Side cabinet with mirror for convenient clothes storage.

NF7 700 Group

Desk 데스크

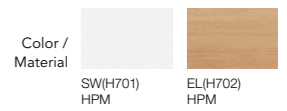

일반 데스크 Standard Desk

일자형 Straight Type	
FSD70012N	1200 · 785 · 730
FSD70014N	1400 · 785 · 730
FDD70016N	1600 · 785 · 730
FDD70018N	1800 · 785 · 730



PC장 데스크 Desk with PC Storage

일자형 Straight Type	
FDD70016SP(L/R)	1600 · 785 · 730
FDD70018SP(L/R)	1800 · 785 · 730
FDD70020SP(L/R)	2000 · 785 · 730



덕트형 Duct Type	
FSD70012DN	1200 · 785 · 730
FSD70014DN	1400 · 785 · 730
FDD70016DN	1600 · 785 · 730
FDD70018DN	1800 · 785 · 730



덕트형 Duct Type	
FDD70016DP(L/R)	1600 · 785 · 730
FDD70018DP(L/R)	1800 · 785 · 730
FDD70020DP(L/R)	2000 · 785 · 730

Color: SW / EL

Color: SW / EL

Storage 스토리지

Color / Material
SW(L701)
LPM



FSB70008NCR

PC장 PC Storage
FSB70008NC(L/R) 800 · 500 · 628

Color, SW



FOW70020R

옷장(1인) Wardrobe(1 person)
FOW70020(L/R) 200 · 500 · 1200

Color, SW



옷장(2인) Wardrobe(2 person)
FOW70040 400 · 500 · 1200

Color, SW



FMS70040BR

멀티스토리지(1인용 수납형) Multi Storage(Storage for 1 Person)
FMS70040B(L/R) 400 · 500 · 1200

Color, SW



FMS70040DR

멀티스토리지(1인용 서랍형) Multi Storage(Drawer Type for 1 Person)
FMS70040K 400 · 500 · 1200

Color, SW



FMS70040AR

멀티스토리지(1인용 옷장+3단 수납형) Multi Storage(Wardrobe for 1 Person+ 3-Tiered Storage)
FMS70040A(L/R) 400 · 500 · 1200

Color, SW

Storage 스토리지

Color / Material
SW(L701) LPM
PF70 GREEN
PF71 BLUE
PF72 RED



FSB70004L

사이드장 Side Cabinet
FSB70004K(L/R) 400 · 500 · 628

Color, SW



사이드장 Side Cabinet
FSB70008 800 · 500 · 628

Color, SW



사이드캐비닛(서류장) Side Cabinet(Lateral Filing Cabinet)

덕트형 Duct Type
FSB70008NBD 800 · 500 · 628
FSB70010NBD 1000 · 500 · 628

Color, SW



FSB70010NADR

사이드캐비닛(콤비장) Side Cabinet(Combination Cabinet)

덕트형 Duct Type
FSB70008NAD(L/R) 800 · 500 · 628
FSB70010NAD(L/R) 1000 · 500 · 628

Color, SW

Panel 가림판

Color / Material
SW(L701) LPM
EL(L702) LPM



사이드 가림판 Side Panel
FSP70007SL 785 · T18 · 300

Color, SW / EL

Drawers 서랍

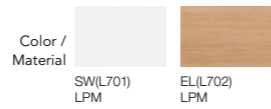

이동서랍 Movable Drawers

2단 2-Level FDB70020K	400 · 500 · 590
3단 3-Level FDB70030K	400 · 500 · 590

Color: SW



고정서랍 Fixed Drawers

2단 2-Level FSR70020K	400 · 500 · 628
3단 3-Level FSR70030K	400 · 500 · 628

Color: SW



이동서랍(서랍전면 사출사양) Movable Drawers (Injection Moulding-based Fronts)

2단 2-Level FDB70020P	400 · 553 · 582
-------------------------	-----------------



전자키 Digital Key FDB70020NP	400 · 553 · 582
3단 3-Level FDB70030P	400 · 553 · 582
전자키 Digital Key FDB70030NP	400 · 553 · 582

Color: SW



이동서랍(서랍전면 사출사양) Movable Drawers (Injection Moulding-based Fronts)

FDB70031P	400 · 553 · 670
-----------	-----------------

Color: SW



고정서랍 Fixed Drawers

2단 2-Level H007058 ~ 59	400 · 500 · 607
----------------------------	-----------------



3단 3-Level H007060 ~ 61	400 · 500 · 607
----------------------------	-----------------

3단 파일행거형 3-Level File Hanger Type H011791 ~ 92	400 · 500 · 607
---	-----------------

Color: PE / SW



하부서랍장 Lower Part Storage

2단(좌/우형) 2-Level(L/R) H007411 ~ 14	400 · 500 · 607
---------------------------------------	-----------------



3단(좌/우형) 3-Level(L/R) H007415 ~ 18	400 · 500 · 607
---------------------------------------	-----------------

Color: PE / SW

Conference Table 회의테이블

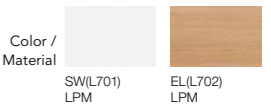

사각 테이블 Square Table FCT70018N 1800 · 1000 · 730

Color: SW / EL



원형 테이블 Round Table FCT70009R ø900 · 730

Color: SW / EL

Accessories 액세서리



하부 그물망 Under-the-desk Net FDT70100

Screen Partition 스크린파티션

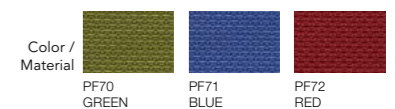

데스크 스크린(패브릭) Desk Privacy Screen(Fabric)

전면 전체 가림 Blocks Front	
FSP70006F	600 · 18 · 832
FSP70008F	800 · 18 · 832
FSP70012F	1200 · 18 · 832
FSP70014F	1400 · 18 · 832
FSP70016F	1600 · 18 · 832
FSP70018F	1800 · 18 · 832
FSP70020F	2000 · 18 · 832

FSP70006F, FSP70008F, FSP70014F,
FSP70016F NF9 높이조절데스크 활용
FSP70006F, FSP70008F, FSP70014F,
FSP70016F are available for NF9
Height-adjustable desk

Color: GN / BU / RE



사이드 스크린 Side Screen FSP70107SG 아크릴 결합시 Acrylic Screen 665 · 46 · 440

ATHENA 3800 Group

A furniture module system that can be utilized in all sorts of spaces

어떤 공간에서도 합리적인 구성이 가능한 모듈 시스템가구

기존의 획일적인 사무환경에서 벗어나 공간 효율에 대한 일반적이고 합리적인 이해를 바탕으로 구성되어 어느 환경에서도 최적의 업무공간을 확보할 수 있는 모듈 시스템 사무가구. 심플한 미니멀리즘 디자인에 투톤 컬러로 산뜻한 분위기를 연출합니다.

A furniture module system that allows you to break from the conventional office environment and to optimize your work space in any environment. The two toned simple and minimalistic design produces a fresh atmosphere.



ATHENA 3800 Group Storage / Extension Worktop

한정된 사무공간의 활용도를 높이기 위해 하부장을 두어 수납공간을 확대할 수 있습니다.
또한 하부장 위 보조상판을 설치하여 작업공간을 확장할 수 있습니다.
In order to maximize the utility of the limited office space, a subsidiary upper board to hold drawers is installed to expand working space.



데스크 FDD3816NSC 사이드캐비닛 FSB3883 상부장 FSU3816
옷장 FOW3820 스크린 FSP3816NH



- 1 사이드 캐비닛 상부에 보조상판을 설치, 작업공간을 확보하여 공간 활용을 극대화하였습니다.
 - 2 CPU 거치대가 부착된 PC하부장은 상하부에 배선과 통풍이 용이하도록 홀을 적용하였습니다.
- 1 The spare shelf installed above the side cabinet helps make better use of a space.
2 CPU tray is attached inside of the door on the lower part of the PC cabinet for added convenience. A hole is present in the upper and lower part of the storage space for easy wiring and ventilation.

ATHENA 3800 Group Storage

옷장 및 다양한 수납형식의 멀티스토리지를 사이드에 배치하여 개인 수납공간을 확대합니다.
Side wardrobe maximizes storage space for user convenience.



- 1 아크릴 소재의 슬라이딩 도어 상부장을 책상 사이드에 비치하여 사용자의 편의성을 제공합니다.
 - 2 옷장 후면 수납공간과 자석 활용이 가능한 패브릭 메모보드.
- 1 Storage in the upper section has an acrylic sliding door and is aligned next to the desk for user convenience.
2 A storage shelf is present on the side of the desk by using the rear space of wardrobe. Magnet attachable fabric board for posting memos.

ATHENA 3800 Group Work Station

파트별 독립성을 유지시켜 업무집중도를 높이고 별도의 시팅 패드를 활용하여 간단한 미팅도 할 수 있습니다.

Sectional independence is maintained, work intensity enhanced, and a separate seating pad can be used to hold simple meetings.



데스크 FDD3816NSC 사이드캐비닛 FSB3883
옷장 FOW3840 파티션 65T Partition



- 1 간단한 미팅을 할 수 있는 팀장용 보조 데스크.
- 2 삼각형 형태의 데스크 다리는 정밀도와 내구성을 높였습니다.
- 3 파티션과 결합되는 행잉 데스크는 보다 견고하고 경제적입니다.
- 4 원터치 엣지 개폐방식의 부드러운 작동이 용이한 댐퍼 적용 데스크 홀캡.

- 1 Manager's side desk for quick talks and discussions.
- 2 Highly durable desk legs made of heavy-duty triangle beam.
- 3 Desk structure combined with a partition provides a more economic and solid system.
- 4 Provides a refined mechanism featuring a damper applied hole cap for smooth operation and one-touch open/shut type.

ATHENA 3800 Group

Desk 데스크

Color / Material	SW(L701) LPM	PE(L402) LPM

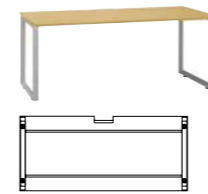

일반 데스크 Standard Desk

FSD3810N	1000 · 800 · 730
FSD3812N	1200 · 800 · 730
FSD3814N	1400 · 800 · 730
FDD3816N	1600 · 800 · 730
FDD3818N	1800 · 800 · 730

Color: SW / PE

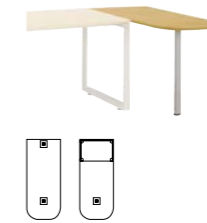

익스텐션 Extension

연결형 Connecting
FPD3806 600 · 1400 · 730

자립형(하부장) Freestanding(Lower Part Storage)
FPD3806S 600 · 1400 · 730

Color: SW / PE

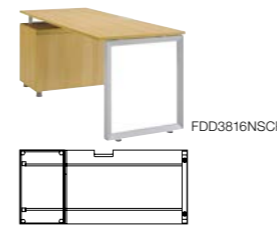

PC장 데스크 Desk with PC Storage

FDD3816NSC(L/R)	1600 · 800 · 730
FDD3818NSC(L/R)	1800 · 800 · 730

FDD3816NSCR

Color: SW / PE



하부장 데스크 Desk with Lower Part Storage

FDD3816NSB(L/R)	1600 · 800 · 730
FDD3818NSB(L/R)	1800 · 800 · 730

FDD3816NSBR

Color: SW / PE

Accessories 액세서리



전선 클립 Wire Clip
FLC3800
3EA/1SET 포장
Package unit: 3 Pieces per Set



시팅 패드 Seating Pad
FSP3800GY 380 · 480 · 35
천 마감 Fabric Finished



다릿발 스페이서 Leg Spacer
FHW3800CB

Storage 스토리지



사이드 캐비닛 Side Cabinet
 FSB3882(L/R) 800 · 500 · 607
 FSB3883(L/R) 800 · 500 · 607

Color: SW / PE

보조상판 Extension Worktop
 FRT3804 400 · 500 · 123
 서랍형 사이드 캐비닛용
 for Side Cabinet Drawer Type

FRT3808 800 · 500 · 123
 사이드 캐비닛용
 for Side Cabinet

Color: SW / PE

사이드 캐비닛(서랍형) Side Cabinet(Drawer Type)
 FSR3820 400 · 500 · 607
 FSR3830 400 · 500 · 607

Color: SW / PE

상부장 Upper Part Storage
 FSU3812(L/R) 1200 · 340 · 583
 FSU3816(L/R) 1600 · 340 · 583

Color: SW / PE

멀티 스토리지 Multi Storage
 옷장(1인용) Wardrobe(1 Person)
 FOW3820(L/R) 200 · 500 · 1190

전자키 매립형 (10Key 타입)
 Digital Key Type (10Key Type)
 FOW3820(L/R)EE 200 · 500 · 1190
 FOW3820(L/R)ED 200 · 500 · 1190

Color: SW / PE

멀티 스토리지 Multi Storage
 옷장(2인용) Wardrobe(2 Person)
 FOW3840 400 · 500 · 1190

전자키 매립형 (10Key 타입)
 Digital Key Type (10Key Type)
 FOW3840(L/R)EE 400 · 500 · 1190
 FOW3840(L/R)ED 400 · 500 · 1190

Color: SW / PE

멀티 스토리지 Multi Storage
 옷장+수납형 Wardrobe+Storage
 FMS3840(L/R) 400 · 500 · 1190

Color: SW / PE

멀티 스토리지 Multi Storage
 3단 수납형 3 Tiered Storage
 FSC3840D(L/R) 400 · 500 · 1190

Color: SW / PE

서랍박스, 수납장, 캐비닛류 : 디지털 키 적용 가능(제품코드: ~N)
 Drawer box, storage, cabinet: digital key applicable.(Product code: ~N)

Conference Table 회의테이블

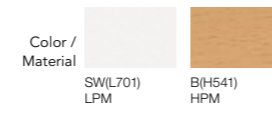

사각 테이블 Square Table
 FCT3818N 1800 · 900 · 730

Color: SW / PE

원형 테이블 Round Table
 FCT3809R Ø900 · 730
 FCT3812R Ø1200 · 730

Color: SW / PE

Storage 스토리지

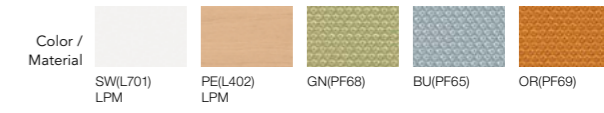

멀티 스토리지 Multi Storage
 옷장(후면 수납형) 1인용
 Wardrobe(Rear Storage Type) for 1 person
 FOW3820A(L/R) 200 · 800 · 1190

전자키형 Digital Key Type
 10KEY 타입 10KEY Type
 FOW3820ALEE 200 · 800 · 1190
 RFID 타입 RFID Type
 FOW3820ALED 200 · 800 · 1190

패브릭 보드 별도 Separate for fabric board
 Color: SW / PE Fabric Color: GN / BU / OR

멀티 스토리지 Multi Storage
 옷장(후면 수납형) 2인용
 Wardrobe(Rear Storage Type) for 2 person
 FOW3840A 400 · 800 · 1190

전자키형 Digital Key Type
 10KEY 타입 10KEY Type
 FOW3820AREE 400 · 800 · 1190
 RFID 타입 RFID Type
 FOW3820ARED 400 · 800 · 1190

패브릭 보드 별도 Separate for fabric board
 Color: SW / PE Fabric Color: GN / BU / OR

패브릭 보드(후면 수납장용) Fabric Board(for Wardrobe - Rear Storage Type)
 FBP3870GN

FBP3870

Color: GN / BU / OR

Panel 가림판



데스크 가림판 Modesty Panel
 FSP3810NL 880 · 350 · T18
 FSP3812NL 1080 · 350 · T18
 FSP3814NL 1280 · 350 · T18
 FSP3816NL 1480 · 350 · T18
 FSP3818NL 1680 · 350 · T18

Color: SW / PE

사이드 가림판(하부) Side Screen
 FSP3807SL 하부 615 · 595 · T12

Color: SW / PE

Drawers 서랍



서랍박스 Drawer Box
 2단 2-Level
 FDB3820K 400 · 500 · 606

3단 3-Level
 FDB3830K 400 · 500 · 606

Color: SW / PE

서랍박스 Drawer Box
 3단 하부파일 행거형
 3-Level(Lower File-hanger Type)
 FDB3832K 420 · 500 · 656

Color: SW / PE

Screen Partition 스크린파티션

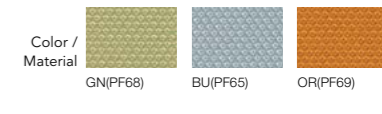

FSP3810NH 880 · 26 · 720
 FSP3812NH 1080 · 26 · 720
 FSP3814NH 1280 · 26 · 720
 FSP3816NH 1480 · 26 · 720
 FSP3818NH 1680 · 26 · 720

Color: GN / BU / OR

사이드 가림판(전체) Side Screen
 FSP3807SH 700 · 26 · 720

Color: GN / BU / OR

SPACE-PRO 5600 Group

The new standard
for future office furniture

사무가구의 스탠다드를 만드는 5600G

인간, 가구, 공간, 커뮤니케이션 등 다각도 분석을 통해 정립한 사무환경의 기준을 제시합니다. 어떠한 업무공간에도 대응 가능한 5600G으로 최적의 사무환경을 완성합니다.

We introduce new standards for office environment established through multi view analysis such as human, furniture, space and communication etc. Completes an optimal office environment with 5600G that can respond to any workplace.



SPACE-PRO 5600 Group Work Station - Storage

상판 곡선과 우레탄 엣지의 조화에서 오는 심리적 안정감은 모서리 부분의 곡선처리를 더하여 사용자의 만족도를 극대화시킵니다.

The combination of curved lines of the worktop with the urethane edge creates comfort and stability for the users.

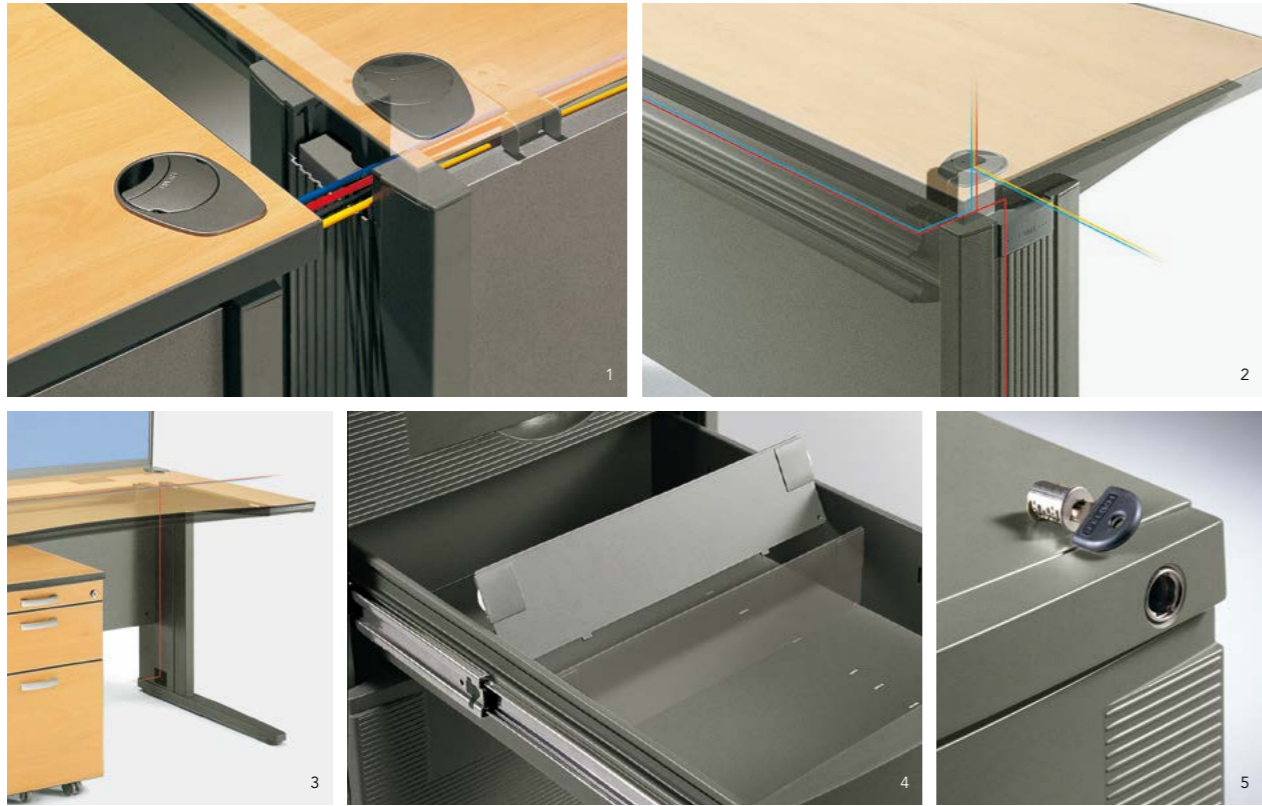

- 1 책상간의 연결시 깔끔하고 편리하게 배선시스템을 구성할 수 있습니다.
- 2 회전식 덕트 커버에 의해 마무리되는 수평배선.(옵션품목)
- 3 발걸림이 없는 'ㄷ'자의 Steel Leg를 도입하여 이동이 자유롭고 수직, 수평의 자유로운 배선 기능으로 최상의 시스템 환경을 제공합니다.
- 4 스프링 홀더를 장착한 디바이더는 이동이 간편하여 서랍내부의 분할이 자유롭습니다.
- 5 서랍에 사용하는 Key는 분리가 가능하며, Key의 분실시 간단히 다른 Key로 교체가 가능합니다.

- 1 Simple junction system when connecting desks.
- 2 Horizontal wiring management with a revolving duct cover. (An optional item)
- 3 Wires can be installed horizontally or vertically underneath the desk.
- 4 Equipped with spring holders, the easily movable divider guarantees free separation of the drawer.
- 5 The key in the pedestal can be replaced if it is lost.

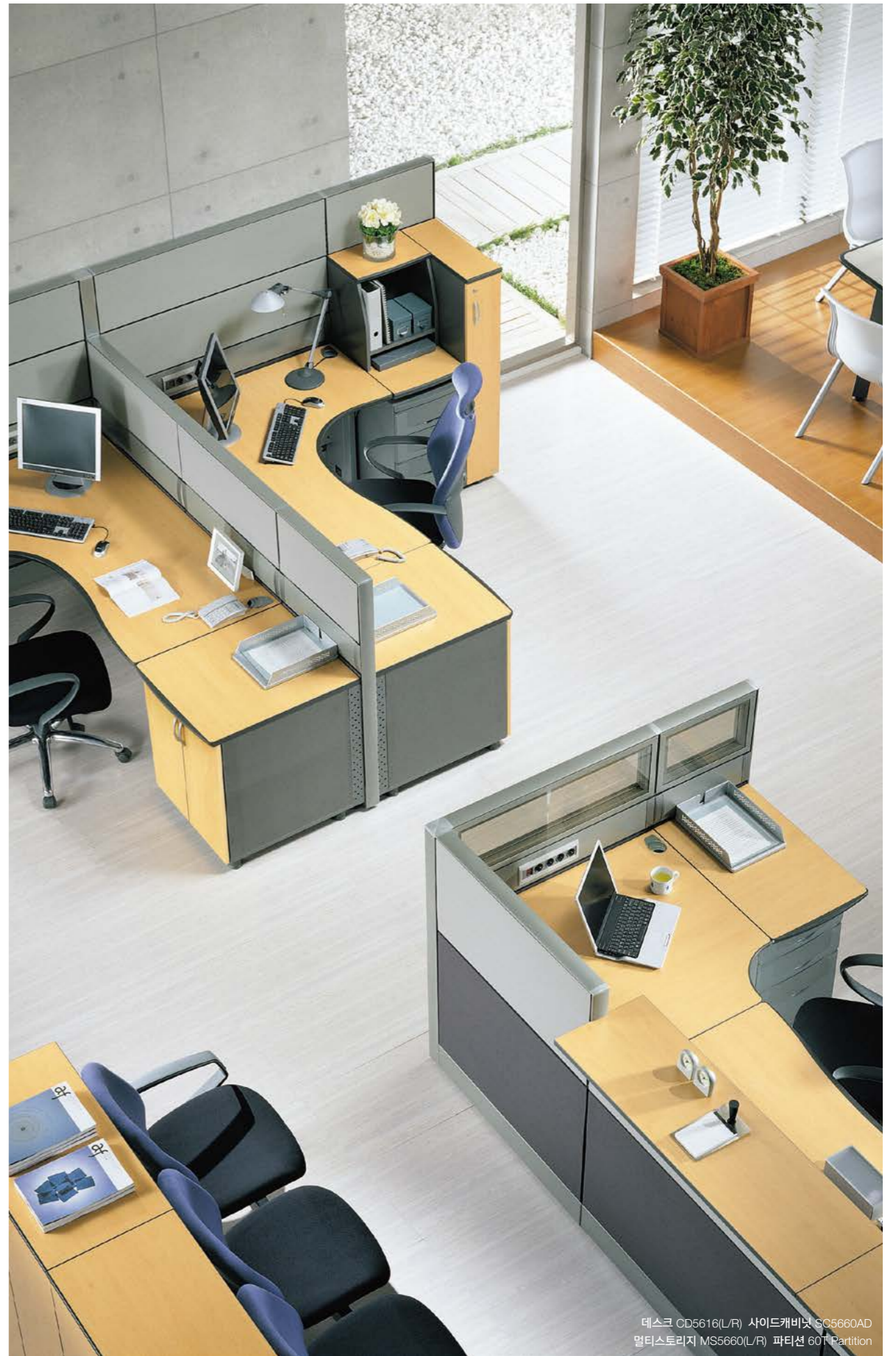

데스크 CD5616(L/R) 사이드캐비닛 SC5660AD
멀티스토리지 MS5660(L/R) 파티션 60T Partition

Desk 데스크



웨이브형 Wave Type
 SD5612 1200 · 700 · 719
 SD5614 1400 · 700 · 719
 Color: G / B

L형 L-shape
 CD5616(L/R) 1600 · 1200 · 719
 CD5618(L/R) 1800 · 1200 · 719
 Color: G / B

120°형 120°-shape
 CD5620 2076 · 1194 · 719
 Color: G / B

익스텐션 유니트 Extension Unit
연결형 Connecting
 PD5660 600 · 1200 · 719
자립형 Freestanding
 PD5660S 600 · 1200 · 719
 Color: G / B

Drawers 서랍



서랍(철제) Drawer(Steel)
 DB5622 402 · 560 · 658
 DB5632 402 · 560 · 658
 Color: G / B

서랍(목재) Drawer(Wooden)
 DB5631 400 · 580 · 590
 Color: G / B

Conference Table 회의테이블

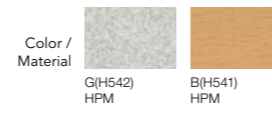

사각 테이블 Square Table
 CT5618 1800 · 1000 · 719
 Color: B / G

원형 테이블 Round Table
 CT5609R Ø900 · 719
 Color: B / G

연결형 Connecting Type
 CT5606 600 · 1000 · T30
 Color: B / G

Storage 스토리지



사이드 캐비닛(철제) Side Cabinet(Steel)
레벨러형 With Leveler
 SR5622(2단 2-Level) 402 · 560 · 694
 SR5632(3단 3-Level) 402 · 560 · 694
캐스터형 With Caster
 SR5633(3단 3-Level) 402 · 560 · 694
 Color: B / G

외장 상판 External Worktop
550측면 연결용
Connects to 550 Width Desk
 SRT5640 402 · 570 · 25
 SRT5645 450 · 570 · 25
 SRT5660 600 · 570 · 25
 Color: B / G

사이드 캐비닛(목재-550측면 연결용) Side Cabinet(Wooden-connects to 550 Width Desk)
 SC5645 450 · 570 · 719
 SC5660 600 · 570 · 719
 Color: B / G

사이드 캐비닛(목재-550측면 연결용) Side Cabinet(Wooden-connects to 550 Width Desk)
 SC5645(L/R) 450 · 570 · 719
 SC5660D 600 · 570 · 719
 Color: B / G

사이드 캐비닛(목재-700측면 연결용) Side Cabinet(Wooden-connects to 700 Width Desk)
 SC5645A 450 · 720 · 719
 SC5660A 600 · 720 · 719
 Color: B / G

사이드 캐비닛(목재-700측면 연결용) Side Cabinet(Wooden-connects to 700 Width Desk)
 SC5660AD 600 · 720 · 719
 Color: B / G

멀티 스토리지 Multi Storage
 MS5660(L/R) 600 · 557 · 1190
 Color: B / G

파일 박스 File Box
 FB5632 402 · 560 · 946
 FB5642 402 · 560 · 1233
 Color: B / G

Cabinet 캐비닛

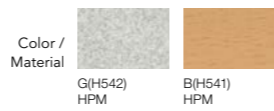

캐비닛(2단) Cabinet(2-Level Shelves)
 LS5520(F/U) 800 · 419 · 809
 LS5522(F/U) 800 · 419 · 809
 LS5524(F/U) 800 · 419 · 809

캐비닛(3단) Cabinet(3-Level Shelves)
 BS5530(F/U) 800 · 419 · 1162
 BS5531(F/U) 800 · 419 · 1162
 BS5534(F/U) 800 · 419 · 1162

Color: B / G

Color: B / G



캐비닛(4단) Cabinet(4-Level Shelves)
 BS5540(F/U) 800 · 419 · 1515 BS5543(F/U) 800 · 419 · 1515
 BS5541(F/U) 800 · 419 · 1515 BS5544(F/U) 800 · 419 · 1515
 BS5542(F/U) 800 · 419 · 1515



캐비닛(5단) Cabinet(5-Level Shelves)
 BS5550(F/U) 800 · 419 · 1868 BS5553(F/U) 800 · 419 · 1868
 BS5551(F/U) 800 · 419 · 1868 BS5554(F/U) 800 · 419 · 1868
 BS5552(F/U) 800 · 419 · 1868

Color: B / G



캐비닛(6단) Cabinet(6-Level Shelves)
 BS5560(F/U) 800 · 419 · 2221 BS5563(F/U) 800 · 419 · 2221
 BS5561(F/U) 800 · 419 · 2221 BS5564(F/U) 800 · 419 · 2221
 BS5562(F/U) 800 · 419 · 2221



옷장 Wardrobe
 4단 높이 4-Level Shelves 5단 높이 5-Level Shelves
 OW5544U 800 · 419 · 1515 OW5554(F/U) 800 · 419 · 1868

Color: B / G

Accessories 액세서리

수평 전선덕트 Horizontal Wire Duct
 DT5612 SD5612용 for SD5612
 DT5614 SD5614용 for SD5614
 DT5612C CD5612용 for CD5612
 DT5616 CD5616용 for CD5616
 DT5618 CD5618용 for CD5618

데스크 하부선반 Lower Desk Shelf
 DS5580 800 · 241 · 380



스크린을 이용한 액세서리 Screen Board Accessories
 메모박스 Memo Box MB7101 108 · 108 · 104
 펜트레이 Pen-tray PT7101 228 · 107 · 40
 펜컵이 A Pen-cup A PC7101 80 · 50 · 110
 펜컵이 B Pen-cup B PC7102 108 · 50 · 127
 서류함이 Paper Box DF7101 228 · 80 · 295

Screen Partition 스크린파티션



통합코드: 벨트패널 구분
 F: 패브릭벨트
 *: 알루미늄 벨트
 패브릭은 그레이, 블루 등 18가지 컬러로 운영됩니다.
 배선벨트형: W700 이상에만 적용, 양면배선벨트형: W1200 이상에만 적용
 The panel fabrics are available in 18 colors, including grey and blue.
 Wiring Belt Type: over W700,
 Double Wiring Belt Type: over W1200



사이드 스크린 Screen

책상 / 코너연결형 책상용 for Desks / Corner-Connection Type

SPW2809	900 · 28 · 406
SPW2812	1200 · 28 · 406
SPW2814	1400 · 28 · 406
SPW2816	1600 · 28 · 406
SPW2818	1800 · 28 · 406

보조책상 / 협탁형 서랍 / 책상 사이드용 for Extension / Side Cabinet / Side Desks

SPS2845	450 · 28 · 406
SPS2860	600 · 28 · 406
SPS2868	680 · 28 · 406

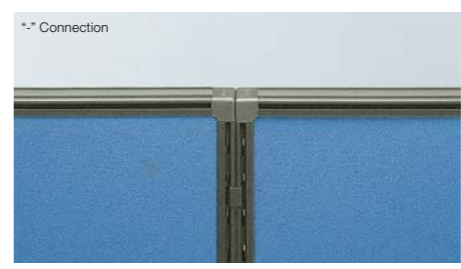

포스트 Post

"L" Connection	POST: SPP2840C
"T" Connection	POST: SPP2840T
"X" Connection	POST: SPP2840P
"-." Connection	패널연결시 견고함을 더하는 연결 보조철물. Hardware accessories that help connect panels more solidly.

SPP2840C	28 · 28 · 406
SPP2840T	28 · 28 · 406
SPP2840P	28 · 28 · 406



65T Partition

A durable structure, an interchangeable and rational space creating partition

견고한 구조, 뛰어난 가변성의 합리적인 공간 창조 파티션

업무의 성격에 따라 자유로이 구성 배치할 수 있으며, 사무실 이전시 구조 변경이 편리합니다.

The 65T Partition is designed to be both versatile to meet the demands of your business and convenient to quickly reconfigure your workplace.



데스크 FDD70016DP(L/R) 사이드캐비닛 FSB70008NAD(L/R)
옷장 FOW70040 파티션 65T Partition



- 1 견고한 구조로 제작되어 안정감이 뛰어나며 벨트 패널 내부에 각종 배선기능과 액세서리 부착 기능을 갖추고 있습니다.
- 2 다양한 컬러의 유리블럭은 사용도를 높이기 위하여 자석 부착 및 판서 기능을 적용하였습니다.
- 3 기구통, 선반, 기본 업무에 필요한 각종 액세서리류를 유리블럭에 쉽게 탈부착할 수 있으므로 수직 공간까지 최대한 활용하였습니다.

- 1 Its durable structure brings stability. The wiring function is inside the belt panel and there is an accessory attaching function.
- 2 Apply magnets and handwriting functionality to the upper glass finishing partitions.
- 3 Pencil trays, shelves and various other accessories can be easily mounted to the glass panels for maximum spatial efficiency.

65T Partition



H : 900mm

일반형 General Type	일면벨트형 Single Belt Type	양면벨트형 Double Belt Type	일면배선벨트형 Single Wiring Belt Type	일면벨트형/일면배선벨트형 Single Belt Type / Single Wiring Belt Type	양면배선벨트형 Double Wiring Belt Type
CTT4509 450 · 65	CBT4509 450 · 65	CBB4509 450 · 65	CWT0609 600 · 65	CWB0609 600 · 65	CWW1209 1200 · 65
CTT0609 600 · 65	CBT0609 600 · 65	CBB0609 600 · 65	CWT0709 700 · 65	CWB0709 700 · 65	
CTT0709 700 · 65	CBT0709 700 · 65	CBB0709 700 · 65	CWT0809 800 · 65	CWB0809 800 · 65	
CTT0809 800 · 65	CBT0809 800 · 65	CBB0809 800 · 65	CWT0909 900 · 65	CWB0909 900 · 65	
CTT0909 900 · 65	CBT0909 900 · 65	CBB0909 900 · 65	CWT1009 1000 · 65	CWB1009 1000 · 65	
CTT1009 1000 · 65	CBT1009 1000 · 65	CBB1009 1000 · 65	CWT1209 1200 · 65	CWB1209 1200 · 65	
CTT1209 1200 · 65	CBT1209 1200 · 65	CBB1209 1200 · 65			



H : 1050mm

일반형 General Type	일면벨트형 Single Belt Type	양면벨트형 Double Belt Type	일면배선벨트형 Single Wiring Belt Type	일면벨트형/일면배선벨트형 Single Belt Type / Single Wiring Belt Type	양면배선벨트형 Double Wiring Belt Type
CTT4510 450 · 65	CBT4510 450 · 65	CBB4510 450 · 65	CWT0610 600 · 65	CWB0610 600 · 65	CWW1210 1200 · 65
CTT0610 600 · 65	CBT0610 600 · 65	CBB0610 600 · 65	CWT0710 700 · 65	CWB0710 700 · 65	
CTT0710 700 · 65	CBT0710 700 · 65	CBB0710 700 · 65	CWT0810 800 · 65	CWB0810 800 · 65	
CTT0810 800 · 65	CBT0810 800 · 65	CBB0810 800 · 65	CWT0910 900 · 65	CWB0910 900 · 65	
CTT0910 900 · 65	CBT0910 900 · 65	CBB0910 900 · 65	CWT1010 1000 · 65	CWB1010 1000 · 65	
CTT1010 1000 · 65	CBT1010 1000 · 65	CBB1010 1000 · 65	CWT1210 1200 · 65	CWB1210 1200 · 65	
CTT1210 1200 · 65	CBT1210 1200 · 65	CBB1210 1200 · 65			

60T Partition

Completion of perfect space are and wiring solution

깔끔한 공간 구획과 배선솔루션의 완성

오랜 시간 사랑받아온 네오스의 대표 파티션으로 프라이버시 보호와 공간구획 기능은 물론 배선에 대한 완벽한 솔루션을 제공합니다.

It is a representative partition of Neoce, which was popular for a long time. It provides perfect solution for privacy and space area function, along with its placement.



데스크 CD5616(L/R) 익스텐션 PD5660S
멀티스토리 MS5660(L/R) 파티션 60T Partition



- 1 파티션 하부를 이용한 전선처리 시스템.
- 2 고정 브라켓을 끼운 후 탑커버를 아래로 밀어 고정합니다.
- 3 커버의 아래쪽을 프레임 하단 전선홀더 홈에 끼운 후, 뒷쪽으로 밀어줍니다.

- 1 Wire management in the base cover.
- 2 Installation after attaching the bracket push down.
- 3 Insert the base cover into the lower part of the frame and push in.

60T Partition

Color / Material	PF13 RED	PF14 LIGHT GRAY	PF22 BLUE	PF48 DARK GRAY	PF49 LIGHT GRAY	PF52 DARK BROWN	PF50 DARK BLUE	PF51 LIGHT BLUE	PF53 LIGHT BROWN

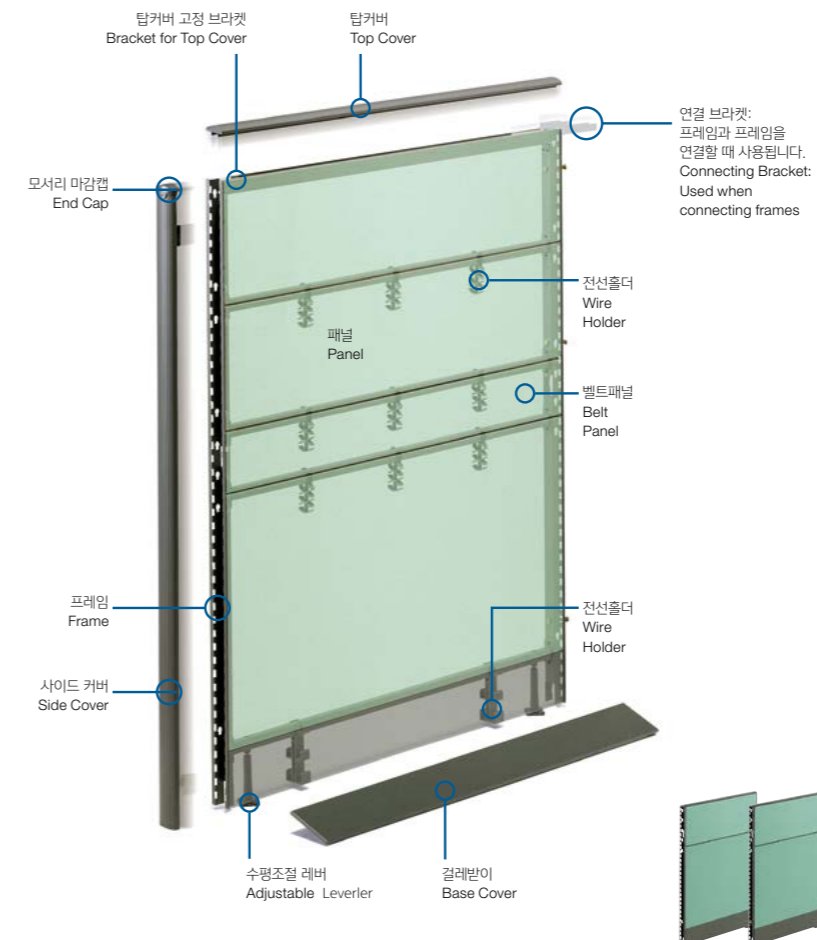

통합코드: 벨트패널 구분
F: 패브릭벨트
*: 알루미늄 벨트

패브릭은 그레이, 블루 등 18가지 컬러로 운영됩니다.
배선벨트형: W700 이상에만 적용, 양면배선벨트형: W1200 이상에만 적용

The panel fabrics are available in 18 colors, including grey and blue.
Wiring Belt Type: over W700,
Double Wiring Belt Type: over W1200

H : 1060mm

일반형 General Type

BN4510	450 · 60	BN9010	900 · 60
BN6010	600 · 60	BN1010	1000 · 60
BN7010	700 · 60	BN1210	1200 · 60
BN8010	800 · 60		

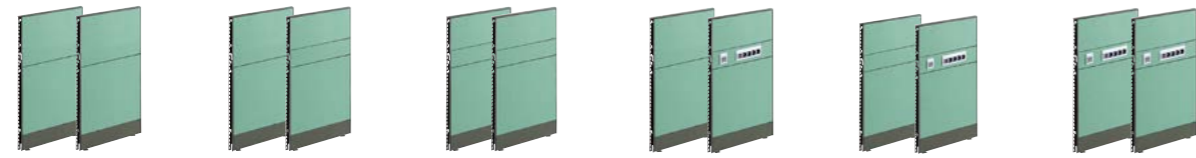

H : 1210mm

일반형 General Type	일면벨트형 Single Belt Type	양면벨트형 Double Belt Type	일면배선벨트형 Single Wiring Belt Type	일면벨트형/일면배선벨트형 Single Belt Type / Single Wiring Belt Type	양면배선벨트형 Double Wiring Belt Type
BN4512 450 · 60	BS4512 450 · 60	BD4512 450 · 60	BW7012 700 · 60	BB7012 700 · 60	BC1212 1200 · 60
BN6012 600 · 60	BS6012 600 · 60	BD6012 600 · 60	BW8012 800 · 60	BB8012 800 · 60	
BN7012 700 · 60	BS7012 700 · 60	BD7012 700 · 60	BW9012 900 · 60	BB9012 900 · 60	
BN8012 800 · 60	BS8012 800 · 60	BD8012 800 · 60	BW1012 1000 · 60	BB1012 1000 · 60	
BN9012 900 · 60	BS9012 900 · 60	BD9012 900 · 60	BW1212 1200 · 60	BB1212 1200 · 60	
BN1012 1000 · 60	BS1012 1000 · 60	BD1012 1000 · 60			
BN1212 1200 · 60	BS1212 1200 · 60	BD1212 1200 · 60			



H : 1510mm

일반형 General Type	일면벨트형 Single Belt Type	양면벨트형 Double Belt Type	일면배선벨트형 Single Wiring Belt Type	일면벨트형/일면배선벨트형 Single Belt Type / Single Wiring Belt Type	양면배선벨트형 Double Wiring Belt Type
BN4515 450 · 60	BS4515 450 · 60	BD4515 450 · 60	BW7015 700 · 60	BB7015 700 · 60	BC1215 1200 · 60
BN6015 600 · 60	BS6015 600 · 60	BD6015 600 · 60	BW8015 800 · 60	BB8015 800 · 60	
BN7015 700 · 60	BS7015 700 · 60	BD7015 700 · 60	BW9015 900 · 60	BB9015 900 · 60	
BN8015 800 · 60	BS8015 800 · 60	BD8015 800 · 60	BW1015 1000 · 60	BB1015 1000 · 60	
BN9015 900 · 60	BS9015 900 · 60	BD9015 900 · 60	BW1215 1200 · 60	BB1215 1200 · 60	
BN1015 1000 · 60	BS1015 1000 · 60	BD1015 1000 · 60			
BN1215 1200 · 60	BS1215 1200 · 60	BD1215 1200 · 60			



H : 1810mm

일반형 General Type	일면벨트형 Single Belt Type	양면벨트형 Double Belt Type	일면배선벨트형 Single Wiring Belt Type	일면벨트형/일면배선벨트형 Single Belt Type / Single Wiring Belt Type	양면배선벨트형 Double Wiring Belt Type
BN4518 450 · 60	BS4518 450 · 60	BD4518 450 · 60	BW7018 700 · 60	BB7018 700 · 60	BC1218 1200 · 60
BN6018 600 · 60	BS6018 600 · 60	BD6018 600 · 60	BW8018 800 · 60	BB8018 800 · 60	
BN7018 700 · 60	BS7018 700 · 60	BD7018 700 · 60	BW9018 900 · 60	BB9018 900 · 60	
BN8018 800 · 60	BS8018 800 · 60	BD8018 800 · 60	BW1018 1000 · 60	BB1018 1000 · 60	
BN9018 900 · 60	BS9018 900 · 60	BD9018 900 · 60	BW1218 1200 · 60	BB1218 1200 · 60	
BN1018 1000 · 60	BS1018 1000 · 60	BD1018 1000 · 60			
BN1218 1200 · 60	BS1218 1200 · 60	BD1218 1200 · 60			



H : 1510mm 상단 1단 유리 Partial Glass Type(1 Upper Level)

일반형 General Type	일면벨트형 Single Belt Type	양면벨트형 Double Belt Type	일면배선벨트형 Single Wiring Belt Type	일면벨트형/일면배선벨트형 Single Belt Type / Single Wiring Belt Type	양면배선벨트형 Double Wiring Belt Type
BN4515G 450 · 60	BS4515G 450 · 60	BD4515G 450 · 60	BW7015G 700 · 60	BB7015G 700 · 60	BC1215G 1200 · 60
BN6015G 600 · 60	BS6015G 600 · 60	BD6015G 600 · 60	BW8015G 800 · 60	BB8015G 800 · 60	
BN7015G 700 · 60	BS7015G 700 · 60	BD7015G 700 · 60	BW9015G 900 · 60	BB9015G 900 · 60	
BN8015G 800 · 60	BS8015G 800 · 60	BD8015G 800 · 60	BW1015G 1000 · 60	BB1015G 1000 · 60	
BN9015G 900 · 60	BS9015G 900 · 60	BD9015G 900 · 60	BW1215G 1200 · 60	BB1215G 1200 · 60	
BN1015G 1000 · 60	BS1015G 1000 · 60	BD1015G 1000 · 60			
BN1215G 1200 · 60	BS1215G 1200 · 60	BD1215G 1200 · 60			



H : 1810mm 상단 1단 유리 Partial Glass Type(1 Upper Level)

일반형 General Type	일면벨트형 Single Belt Type	양면벨트형 Double Belt Type	일면배선벨트형 Single Wiring Belt Type	일면벨트형/일면배선벨트형 Single Belt Type / Single Wiring Belt Type	양면배선벨트형 Double Wiring Belt Type
BN4518G 450 · 60	BS4518G 450 · 60	BD4518G 450 · 60	BW7018G 700 · 60	BB7018G 700 · 60	BC1218G 1200 · 60
BN6018G 600 · 60	BS6018G 600 · 60	BD6018G 600 · 60	BW8018G 800 · 60	BB8018G 800 · 60	
BN7018G 700 · 60	BS7018G 700 · 60	BD7018G 700 · 60	BW9018G 900 · 60	BB9018G 900 · 60	
BN8018G 800 · 60	BS8018G 800 · 60	BD8018G 800 · 60	BW1018G 1000 · 60	BB1018G 1000 · 60	
BN9018G 900 · 60	BS9018G 900 · 60	BD9018G 900 · 60	BW1218G 1200 · 60	BB1218G 1200 · 60	
BN1018G 1000 · 60	BS1018G 1000 · 60	BD1018G 1000 · 60			
BN1218G 1200 · 60	BS1218G 1200 · 60	BD1218G 1200 · 60			

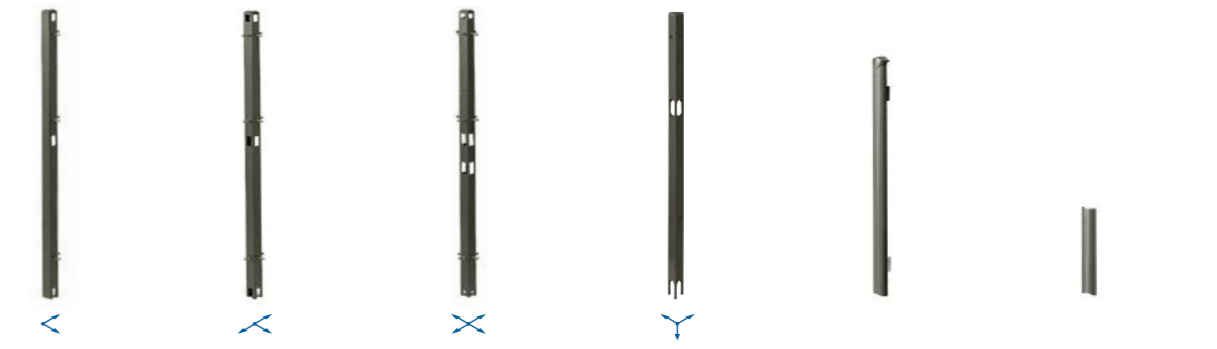

포스트 Post

사이드 커버 Side Cover

L형 L-configuration	T형 T-configuration	X형 X-configuration	Y형 Y-configuration	일반형 Standard Type	단차이형 Change of Height Trim
HP1000A H1060용 for H1060	HP1000B H1060용 for H1060	HP1000C H1060용 for H1060	HP1000D H1060용 for H1060	HE1000 H1060용 for H1060	HE150 H150용 for H150
HP1200A H1210용 for H1210	HP1200B H1210용 for H1210	HP1200C H1210용 for H1210	HP1200D H1210용 for H1210	HE1200 H1210용 for H1210	HE300 H300용 for H300
HP1500A H1510용 for H1510	HP1500B H1510용 for H1510	HP1500C H1510용 for H1510	HP1500D H1510용 for H1510	HE1500 H1510용 for H1510	HE450 H450용 for H450
HP1800A H1810용 for H1810	HP1800B H1810용 for H181	HP1800C H1810용 for H181	HP1800D H1810용 for H1810	HE1800 H1810용 for H1810	HE600 H600용 for H600 HE750 H750용 for H750



벨트 패널 Belt Panel(W · H · T)

BUP4514	436 · 142 · 10
BUP6014	586 · 142 · 10
BUP7014	686 · 142 · 10
BUP8014	786 · 142 · 10
BUP9014	886 · 142 · 10
BUP1014	986 · 142 · 10
BUP1214	1186 · 142 · 10



배선 벨트 패널 Wiring Belt Panel(W · H · T)

BWP7014	686 · 142 · 10
BWP8014	786 · 142 · 10
BWP9014	886 · 142 · 10
BWP1014	986 · 142 · 10
BWP1214	1186 · 142 · 10



파티션 보조물 Partition Support

안정각 Stabilizer
HY01 280 · 50 · 366

벽고정 철물
Wall-Mounted Partition Fastener
HC01 65 · 40 · 60

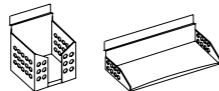

액세서리(액세서리바용)
Accessories (for Accessory Bar)

메모박스 Memo Box
MB7101 108 · 108 · 104

펜트레이 Pen-tray
PT7101 228 · 107 · 40

펜꽂이 A Pen-cup A
PC7101 80 · 50 · 110

펜꽂이 B Pen-cup B
PC7102 108 · 50 · 127

서류꽂이 Paper Box
DF7101 228 · 80 · 295

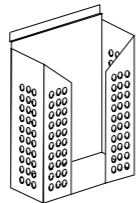
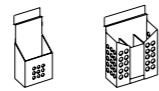

벨트패널 배선용 Receptacles and Cords

4구 멀티 Receptacle
MT400

랜 모듈러 Lan Conduit
LA402

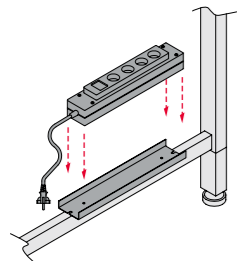

와이어 톨 Wire Management Tools
파티션 하부 멀티탭(연결용)
Receptacle for Lower Part(Connector)
MT404N
1EA/4인 사용함
1EA per 4 Persons



액세서리바 Accessory Bar

AB600
AB700
AB800
AB900
AB1000
AB1200

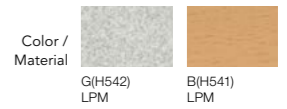

선반 Shelf

낮은 오픈선반 Low Open Shelf

LS4520	445 · 344 · 200
LS6020	595 · 344 · 200
LS7020	695 · 344 · 200
LS8020	795 · 344 · 200
LS9020	895 · 344 · 200
LS1020	995 · 344 · 200
LS1220	1195 · 344 · 200



높은 오픈선반 High Open Shelf

HS4540	445 · 344 · 392
HS6040	595 · 344 · 392
HS7040	695 · 344 · 392
HS8040	795 · 344 · 392
HS9040	895 · 344 · 392
HS1040	995 · 344 · 392
HS1240	1195 · 344 · 392



디바이더 Divider

DV7101 204 · 80 · 155

Color: B / G



카운터 상판 Counter Top

사각형 Rectangular

SS5504	450 · 360 · T23
SS5506	600 · 360 · T23
SS5508	800 · 360 · T23
SS5510	1000 · 360 · T23
SS5512	1200 · 360 · T23
SS5514	1400 · 360 · T23
SS5516	1600 · 360 · T23



코너용 for Corner

SS5504R 410 · 410 · T23

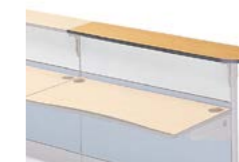

라운드형 Round

SS5506R	780 · 360 · T23
SS5508R	980 · 360 · T23
SS5510R	1180 · 360 · T23
SS5512R	1380 · 360 · T23

Color: B / G

브라켓 Bracket

브라켓은 패널과 행잉상판과의 결합, 행잉상판과 상판을 연결해 주는 설치물로서 행잉상판용과 카운터 상판용 브라켓이 있습니다.

Brackets connect panels to worktops and worktops to each other. 2 types of brackets are available for worktop and countertop.

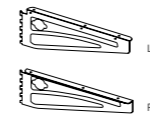

1 행잉상판용 싱글브라켓
Single Bracket for Worktop
HBR01(L/R) 38 · 517 · 161



2 행잉상판용 더블브라켓
Double Bracket for Worktop
HBR02 82 · 517 · 161

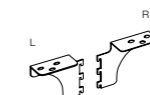

3 행잉상판용 코너/측면브라켓
Corner/Side Bracket for Worktop
HBR04(L/R) 130 · 45 · 95



4 연결평철
Connecting Plate Bar for Worktop
HNC07 69 · 44 · T2.3



5 카운터상판용 연결평철
Countertop Connecting Plate Bar
HNC06 69 · 29 · T2.3

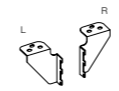

6 행잉상판용 측면브라켓
Side Bracket for Worktop
HBR03(L/R) 92 · 48 · 95

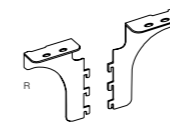

7 카운터상판용 브라켓
Countertop Bracket
HBR05(L/R) 188 · 33 · 95



8 액세서리바
Accessory Bar
AB1000

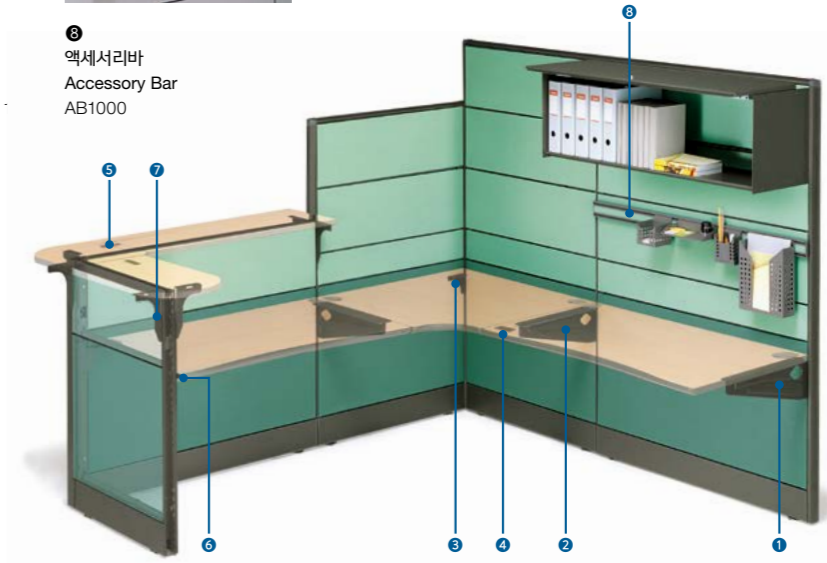

30T Partition NEW

Economical partition in simple and concise style

심플하고 간결한 스타일의 경제적인 파티션

더욱 슬림한 파티션으로 공간이 시원스럽게 보이며, 업무영역 및 개인 업무 보호로 기존 파티션보다 효과적인 커뮤니케이션 환경을 제공합니다.

The slimmer partition makes the space look cooler and the work area and personal work protection provide more effective communication environment than the existing partition.



데스크 우레탄형 H010792 서랍 H010358 의자 TOH55852LWDG
스크린 H009832 / H009837



코너 라운드형 파티션 Corner Round Partition

라운드 곡선형을 적용하여 부드러운 오피스 분위기를 연출해줍니다.

Apply round curves to create a soft office feel.



코너 90도형 단면/분할 파티션 Corner 90-degree section / Division partition

코너를 직선으로 구성하여 간결하면서도 모던한 분위기의 오피스를 만들어줍니다.

Creates a simple, modern office with straight corners. Wire passing type, split type, upper magnet type, stacking partition.

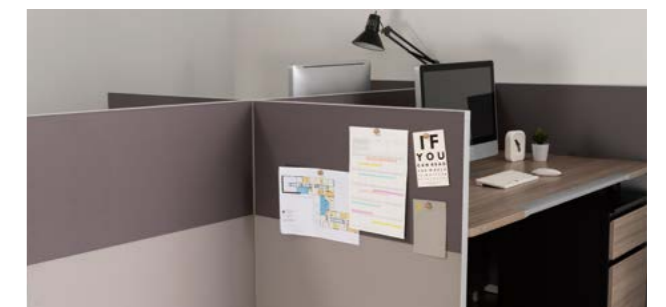
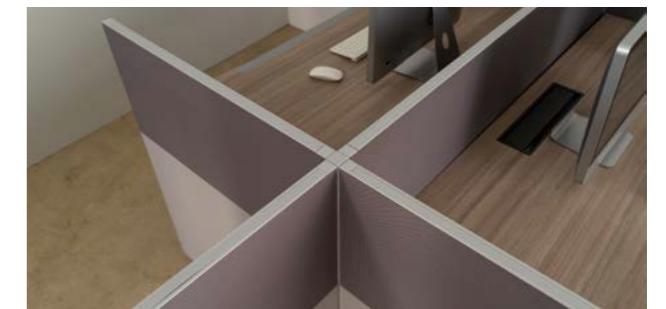

30T Partition



H : 1050mm

일반형 General Type	전선통과형 Wire Passing Type	분할형 Split Type	분할형 / 전선통과형 Split Type / Wire Passing Type
H009756 600 · 30 · 1050	H009764 600 · 30 · 1050	H009778 600 · 30 · 1050	H009786 600 · 30 · 1050
H009757 700 · 30 · 1050	H009765 700 · 30 · 1050	H009779 700 · 30 · 1050	H009787 700 · 30 · 1050
H009758 800 · 30 · 1050	H009766 800 · 30 · 1050	H009780 800 · 30 · 1050	H009788 800 · 30 · 1050
H009759 1000 · 30 · 1050		H009781 1000 · 30 · 1050	
H009760 1200 · 30 · 1050		H009782 1200 · 30 · 1050	
H009761 1400 · 30 · 1050		H009783 1400 · 30 · 1050	
H009762 1600 · 30 · 1050		H009784 1600 · 30 · 1050	
H009763 1800 · 30 · 1050		H009785 1800 · 30 · 1050	



H : 1050mm

분할형 / 상부자석형 Split Type / Upper Magnet Type	분할형 / 상부자석형 / 전선통과형 Split Type / Upper Magnet Type / Wire Passing Type	코너라운드형 Corner Round Type	코너라운드형 / 전선통과형 Corner Round Type / Wire Passing Type
H009800 600 · 30 · 1050	H009808 600 · 30 · 1050	H009830 600 · 30 · 1050	H009838 600 · 30 · 1050
H009801 700 · 30 · 1050	H009809 700 · 30 · 1050	H009831 700 · 30 · 1050	H009839 700 · 30 · 1050
H009802 800 · 30 · 1050	H009810 800 · 30 · 1050	H009832 800 · 30 · 1050	H009840 800 · 30 · 1050
H009803 1000 · 30 · 1050		H009833 1000 · 30 · 1050	
H009804 1200 · 30 · 1050		H009834 1200 · 30 · 1050	
H009805 1400 · 30 · 1050		H009835 1400 · 30 · 1050	
H009806 1600 · 30 · 1050		H009836 1600 · 30 · 1050	
H009807 1800 · 30 · 1050		H009837 1800 · 30 · 1050	



H : 1050mm

코너라운드형 / 분할형 Corner Round Type / Split Type	코너라운드형 / 분할형 / 전선통과형 Corner Round Type / Split Type / Wire Passing Type	코너라운드형 / 분할형 / 자석형 Corner Round Type / Split Type / Upper Magnet Type	코너라운드형 / 분할형 / 자석형 / 전선통과형 Corner Round Type / Split Type / Upper Magnet Type / Wire Passing Type
H011774 600 · 30 · 1050	H011782 600 · 30 · 1050	H011744 600 · 30 · 1050	H011752 600 · 30 · 1050
H011775 700 · 30 · 1050	H011783 700 · 30 · 1050	H011745 700 · 30 · 1050	H011753 700 · 30 · 1050
H011776 800 · 30 · 1050	H011784 800 · 30 · 1050	H011746 800 · 30 · 1050	H011754 800 · 30 · 1050
H011777 1000 · 30 · 1050		H011747 1000 · 30 · 1050	
H011778 1200 · 30 · 1050		H011748 1200 · 30 · 1050	
H011779 1400 · 30 · 1050		H011749 1400 · 30 · 1050	
H011780 1600 · 30 · 1050		H011750 1600 · 30 · 1050	
H011781 1800 · 30 · 1050		H011751 1800 · 30 · 1050	

30T Partition

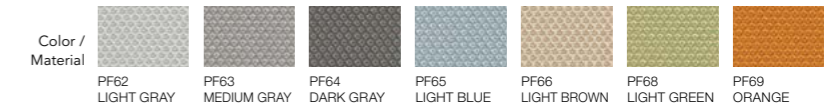

H : 1200mm

일반형 General Type	전선통과형 Wire Passing Type	분할형 Split Type	분할형 / 전선통과형 Split Type / Wire Passing Type
H009767 600 · 30 · 1200	H009775 600 · 30 · 1200	H009789 600 · 30 · 1200	H009797 600 · 30 · 1200
H009768 700 · 30 · 1200	H009776 700 · 30 · 1200	H009790 700 · 30 · 1200	H009798 700 · 30 · 1200
H009769 800 · 30 · 1200	H009777 800 · 30 · 1200	H009791 800 · 30 · 1200	H009799 800 · 30 · 1200
H009770 1000 · 30 · 1200		H009792 1000 · 30 · 1200	
H009771 1200 · 30 · 1200		H009793 1200 · 30 · 1200	
H009772 1400 · 30 · 1200		H009794 1400 · 30 · 1200	
H009773 1600 · 30 · 1200		H009795 1600 · 30 · 1200	
H009774 1800 · 30 · 1200		H009796 1800 · 30 · 1200	



H : 1200mm

분할형 / 상부자석형 Split Type / Upper Magnet Type	분할형 / 상부자석형 / 전선통과형 Split Type / Upper Magnet Type / Wire Passing Type	코너라운드형 Corner Round Type	코너라운드형 / 전선통과형 Corner Round Type / Wire Passing Type
H009811 600 · 30 · 1200	H009819 600 · 30 · 1200	H009841 600 · 30 · 1200	H009849 600 · 30 · 1200
H009812 700 · 30 · 1200	H009820 700 · 30 · 1200	H009842 700 · 30 · 1200	H009850 700 · 30 · 1200
H009813 800 · 30 · 1200	H009821 800 · 30 · 1200	H009843 800 · 30 · 1200	H009851 800 · 30 · 1200
H009814 1000 · 30 · 1200		H009844 1000 · 30 · 1200	
H009815 1200 · 30 · 1200		H009845 1200 · 30 · 1200	
H009816 1400 · 30 · 1200		H009846 1400 · 30 · 1200	
H009817 1600 · 30 · 1200		H009847 1600 · 30 · 1200	
H009818 1800 · 30 · 1200		H009848 1800 · 30 · 1200	



H : 1200mm

코너라운드형 / 분할형 Corner Round Type / Split Type	코너라운드형 / 분할형 / 전선통과형 Corner Round Type / Split Type / Wire Passing Type	코너라운드형 / 분할형 / 자석형 Corner Round Type / Split Type / Upper Magnet Type	코너라운드형 / 분할형 / 자석형 / 전선통과형 Corner Round Type / Split Type / Upper Magnet Type / Wire Passing Type
H011763 600 · 30 · 1200	H011771 600 · 30 · 1200	H011733 600 · 30 · 1200	H011741 600 · 30 · 1200
H011764 700 · 30 · 1200	H011772 700 · 30 · 1200	H011734 700 · 30 · 1200	H011742 700 · 30 · 1200
H011765 800 · 30 · 1200	H011773 800 · 30 · 1200	H011735 800 · 30 · 1200	H011743 800 · 30 · 1200
H011766 1000 · 30 · 1200		H011736 1000 · 30 · 1200	
H011767 1200 · 30 · 1200		H011737 1200 · 30 · 1200	
H011768 1400 · 30 · 1200		H011738 1400 · 30 · 1200	
H011769 1600 · 30 · 1200		H011739 1600 · 30 · 1200	
H011770 1800 · 30 · 1200		H011740 1800 · 30 · 1200	

Workplace

System

30T Partition

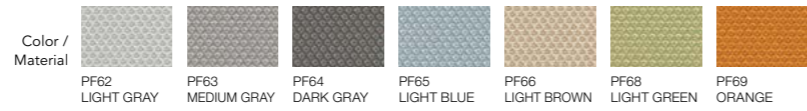

H : 1500mm

일반형 General Type	분할형 Split Type	분할형 / 상부자석형 General Type / Split Type / Upper Magnet Type	코너라운드형 Corner Round Type
H011015 600 · 30 · 1500	H011717 600 · 30 · 1500	H009822 600 · 30 · 1500	H009852 600 · 30 · 1500
H011016 700 · 30 · 1500	H011718 700 · 30 · 1500	H009823 700 · 30 · 1500	H009853 700 · 30 · 1500
H011017 800 · 30 · 1500	H011719 800 · 30 · 1500	H009824 800 · 30 · 1500	H009854 800 · 30 · 1500
H011018 1000 · 30 · 1500	H011720 1000 · 30 · 1500	H009825 1000 · 30 · 1500	H009855 1000 · 30 · 1500
H011019 1200 · 30 · 1500	H011721 1200 · 30 · 1500	H009826 1200 · 30 · 1500	H009856 1200 · 30 · 1500
	H011722 1400 · 30 · 1500	H009827 1400 · 30 · 1500	H009857 1400 · 30 · 1500
	H011723 1600 · 30 · 1500	H009828 1600 · 30 · 1500	H009858 1600 · 30 · 1500
	H011724 1800 · 30 · 1500	H009829 1800 · 30 · 1500	H009859 1800 · 30 · 1500



H : 1500mm

코너라운드형 / 전선통과형 Corner Round Type / Wire Passing Type	코너라운드형 / 분할형 Corner Round Type / Split	코너라운드형 / 분할형 / 자석형 Corner Round Type / Split Type / Upper Magnet Type
H009860 600 · 30 · 1500	H011755 600 · 30 · 1500	H011725 600 · 30 · 1500
H009861 700 · 30 · 1500	H011756 700 · 30 · 1500	H011726 700 · 30 · 1500
H009862 800 · 30 · 1500	H011757 800 · 30 · 1500	H011727 800 · 30 · 1500
	H011758 1000 · 30 · 1500	H011728 1000 · 30 · 1500
	H011759 1200 · 30 · 1500	H011729 1200 · 30 · 1500
	H011760 1400 · 30 · 1500	H011730 1400 · 30 · 1500
	H011761 1600 · 30 · 1500	H011731 1600 · 30 · 1500
	H011762 1800 · 30 · 1500	H011732 1800 · 30 · 1500



포스트 Post

일반형 General Type	코너라운드형 Corner Round Type
L형 L-configuration	L형 L-configuration
H010710 H1050용 for H1050	H010748 H1050용 for H1050
H010713 H1200용 for H1200	H010751 H1200용 for H1200
H010716 H1500용 for H1500	H010754 H1500용 for H1500
T형 T-configuration	T형 T-configuration
H010711 H1050용 for H1050	H010749 H1050용 for H1050
H010714 H1200용 for H1200	H010752 H1200용 for H1200
H010717 H1500용 for H1500	H010755 H1500용 for H1500
X형 X-configuration	X형 X-configuration
H010712 H1050용 for H1050	H010750 H1050용 for H1050
H010715 H1200용 for H1200	H010753 H1200용 for H1200
H010718 H1500용 for H1500	H010756 H1500용 for H1500

마감바 Post

일반형 General Type	코너라운드형 Corner Round Type
H010719 H1050용 for H1050	H010757 H1050용 for H1050
H010720 H1200용 for H1200	H010758 H1200용 for H1200
H010721 H1500용 for H1500	H010759 H1500용 for H1500

002 Group

User customized Cabinet 002 Group

002 Group Cabinet

사용자 맞춤형 캐비닛 002G

안정적인 구조의 캐비닛은 다양한 크기의 서류의 수납이 가능합니다. 사용자가 원하는 높이는 물론 도어와 시건 타입을 선택할 수 있습니다. Cabinet with stable structure can store documents with various sizes. It may select door and siegen type, along with height a that user wants it to be.



1

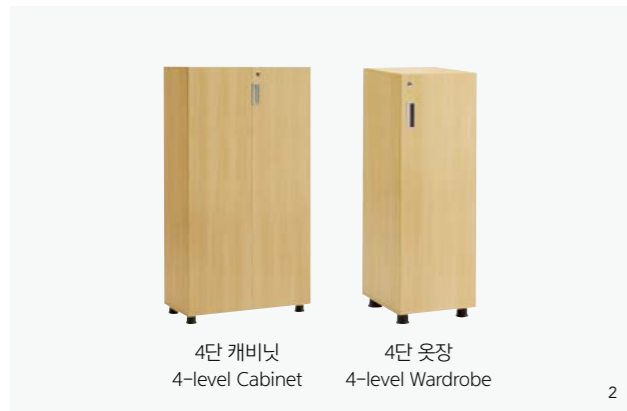

2



3

- 1 2단 H: 807mm / 3단 H: 1160mm / 4단 H: 1490mm
5단 H: 1866mm / 6단 H: 2219mm
 - 2 캐비닛과 옷장 품목 선택 가능.
 - 3 도어 및 시건 사양 선택가능.(일반키, 전자키)
- 1 Level 2 H: 807mm / Level 3 H: 1160mm / Level 4 H: 1490mm
Level 5: 1866mm / Level 6 H: 2219mm
 - 2 May choose cabinet and closet category.
 - 3 May choose door and siegen specifications.
(general key, electronic key)

002 Group

Cabinet 캐비닛

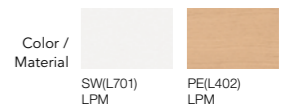

캐비닛(2단) Cabinet(2-Level Shelves)

FLS00220 800 · 420 · 807
FLS00224 800 · 420 · 807

Color, SW / PE



캐비닛(3단) Cabinet(3-Level Shelves)

FBS00230 800 · 420 · 1160
FBS00231 800 · 420 · 1160
FBS 00234 800 · 420 · 1160

캐비닛 마감뒷판(3단)
Back Panel of Cabinet (3-Level)
FBS0023BT 800 · 420 · 1513

전자키 Digital Key Type
10KEY 타입 10KEY Type
FBS00234ND 800 · 420 · 1160
RFID 타입 RFID Type
FBS00234NE 800 · 420 · 1160

Color, SW / PE



캐비닛(4단) Cabinet(4-Level Shelves)

FBS00240 800 · 420 · 1513
FBS00241 800 · 420 · 1513
FBS00242 800 · 420 · 1513
FBS00243 800 · 420 · 1513
FBS00244 800 · 420 · 1513

전자키 Digital Key Type
10KEY 타입 10KEY Type
FBS00243ND / FBS00244ND
800 · 420 · 1513
RFID 타입 RFID Type
FBS00243NE / FBS00244NE
800 · 420 · 1513

Color, SW / PE



캐비닛(5단) Cabinet(5-Level Shelves)

FBS00250 800 · 420 · 1866
FBS00251 800 · 420 · 1866
FBS00252 800 · 420 · 1866
FBS00253 800 · 420 · 1866
FBS00254 800 · 420 · 1866

전자키 Digital Key Type
10KEY 타입 10KEY Type
FBS00253ND 800 · 420 · 1866
RFID 타입 RFID Type
FBS00253NE 800 · 420 · 1866

Color, SW / PE



캐비닛(6단) Cabinet(6-Level Shelves)

FBS 00260 800 · 420 · 2219
FBS 00261 800 · 420 · 2219
FBS 00262 800 · 420 · 2219
FBS 00263 800 · 420 · 2219
FBS 00264 800 · 420 · 2219

전자키 Digital Key Type
10KEY 타입 10KEY Type
FBS00263ND / FBS00264ND
800 · 420 · 2219
RFID 타입 RFID Type
FBS00263NE / FBS00264NE
800 · 420 · 2219

Color, SW / PE



옷장 Wardrobe

4단 높이 4-Level Shelves
FOW00244 600 · 420 · 1513
전자키 Digital Key Type
10KEY 타입 10KEY Type
FOW00244ND 600 · 420 · 1513
RFID 타입 RFID Type
FOW00244NE 600 · 420 · 1513

5단 높이 5-Level Shelves
FOW00254 600 · 420 · 1866
전자키 Digital Key Type
10KEY 타입 10KEY Type
FOW00254ND 600 · 420 · 1866
RFID 타입 RFID Type
FOW00254NE 600 · 420 · 1866

6단 높이 6-Level Shelves
FOW00264 600 · 420 · 2219
전자키 Digital Key Type
10KEY 타입 10KEY Type
FOW00264ND 600 · 420 · 2219
RFID 타입 RFID Type
FOW00264NE 600 · 420 · 2219

Color, SW / PE

002 Group NEW Locker Storage Closet

변동좌석제를 적용한 오피스에서 개인의 물품을 안전하게 보관할 수 있는 락장치형 사물함입니다.
It is a lock type locker that can safely store personal items in the office with variable seating system.



- 1 사용자가 원하는 높이를 선택해서 사용할 수 있도록 3단 이동선반을 적용하였으며, 이동선반 사용시 선반의 낙하방지를 위해 4개의 이동축다보를 사용하여 안전합니다.
- 2 선반을 이용해서 사용하거나 이동선반 없이 넓은 공간으로도 사용이 가능합니다.
- 3 리바트 오피스 툴박스가 들어갈 수 있는 사이즈로 제작되었습니다.
- 4 락 장치는 일반 열쇠형과 전자키형 중 선택이 가능합니다.
전자키형은 사용자가 직접 비밀번호를 설정하여 별도의 열쇠가 필요하지 않습니다.
- 5 외관상 노출되지 않도록 제품 안쪽으로 코너레벨러를 설치해 수평을 맞출 수 있습니다.
- 6 겨울 코트나 패딩처럼 두꺼운 의류도 수납이 가능하며 옷걸이와 함께 제공되는 S자고리는 가방이나 개인소지품을 걸어 놓을 수 있습니다.

- 1 A three-stage moving shelf has been applied so that the user can select and use the height desired.
It is safe to use four moving tabs to prevent falling of the shelf when using the moving shelf.
- 2 It can be used as a shelf or in a large space without a moving shelf.
- 3 It is designed for the Livart Office Toolbox to fit into.
- 4 The lock can be selected from the standard key type and the electronic key type.
The electronic key type does not require a separate key because the user sets a password.
- 5 The corner leveler can be leveled inside the product to prevent it from being exposed.
- 6 Thick clothing such as winter coats and padding can be stored, and the S-hook, which comes with a hanger, can be used for hanging bags or personal belongings.



사물함 H010430 / H010439 / H010440

002 Group

Color / Material	
SW	WD
LPM	LPM



1열 4단사물함 일반형
Row 4 Steps, Locker, General Type
H011159(SW) 400 · 415 · 1865
H011160(WD) 400 · 415 · 1865

Color. SW / WD



1열 4단사물함 스마트형
Row 4 Steps, Locker, Smart Type
H011167(SW) 400 · 415 · 1865
H011168(WD) 400 · 415 · 1865

Color. SW / WD



1열 3단사물함 일반형
Row 3 Steps, Locker, General Type
H011161(SW) 400 · 415 · 1865
H011162(WD) 400 · 415 · 1865

Color. SW / WD



1열 3단사물함 스마트형
Row 3 Steps, Locker, Smart Type
H011169(SW) 400 · 415 · 1865
H011170(WD) 400 · 415 · 1865

Color. SW / WD



1열 옷장형 사물함 일반형 (좌/우형)
Row 2 Steps, Wardrobe,
General Type (L/R Type)
H011163(SW/좌형 L Type) 400 · 415 · 1865
H011164(WD/좌형 L Type) 400 · 415 · 1865
H011165(SW/우형 R Type) 400 · 415 · 1865
H011166(WD/우형 R Type) 400 · 415 · 1865

Color. SW / WD



1열 옷장형 사물함 스마트형 (좌/우형)
Row 2 Steps, Wardrobe,
Smart Type (L/R Type)
H011171(SW/좌형 L Type) 400 · 415 · 1865
H011172(WD/좌형 L Type) 400 · 415 · 1865
H011173(SW/우형 R Type) 400 · 415 · 1865
H011174(WD/우형 R Type) 400 · 415 · 1865

Color. SW / WD

Accessories NEW

Various office furniture and equipment according to user needs

사용자에 따른 다양한 오피스 아이템

다양하게 변화되어 가고 있는 오피스 환경 속에서 리바트만의 세심한 아이디어로 탄생한 효율적인 오피스 아이템입니다.

It is an efficient office furniture created with the LIVART's own thoughtful ideas for office environment continuing to change.



툴박스 Toolbox

- 1 전면의 플라스틱 잠금 장치는 쉽게 OPEN/CLOSE를 할 수 있도록 되어 있습니다.
- 2 외부 커버를 열고 각도조절 다리를 활용해 4단계 각도(15도)조절이 가능하며, 노트북 거치를 편리하게 사용할 수 있습니다.
- 3 내부 수납함은 A4사이즈로 개인 물품 및 서류 보관에 용이하고, 탈부착 펜트레이가 있어 필기구 수납에도 편리합니다.

- 1 The plastic lock on the front makes it easy to OPEN/CLOSE.
- 2 Open the outer cover and adjust the angle and height through 4 reclining stages by 15 degree each. Open the laptop stand of the outer cover and hold your laptop in it.
- 3 The drawer with a removable hanging pen tray is large enough to hold A4-size documents and is secured so that pens and other items inside the pen tray will not slip out.



모니터 선반 Monitor Shelf

높낮이 조절이 가능하며 기존 오피스 액세서리 호환하여 사용할 수 있습니다. 듀얼 모니터 사용시 연결형을 추가 구매하여 사용할 수 있습니다.

This height adjustable monitor shelf is compatible with existing LIVART OFFICE accessories. Additional monitor shelf for dual monitors is available for purchase.



독립형

거치형

휴대폰 거치대 Mobile Phone Stands/Holder

좌석 이동 시에도 사용이 가능한 이동식 무선충전기로 업무의 효율을 높여주며, 충전 및 거치대로 사용자에게 편리함을 제공합니다.

This mobile wireless charger, which can be used even when moving a seat, improves work efficiency and provides users with convenience as a charger as well as stands.

Accessory Item



모니터선반 일반형 Monitor Base
H009869 527 · 260 · 100



모니터선반 연결형
Monitor Base, Extend Type
H009870 389 · 260 · 100



모니터선반 무선충전
Wireless Charger for Monitor Base
H009871



모니터선반 USB포트
USB Port Outlet for Monitor Base



휴대폰 거치대 (독립형)
Mobile Base (Independent Type)
H010354 100 · 171 · 133



휴대폰 거치대 (거치형)
Mobile Base (Connecting Type)
H010355 90 · 84 · 108



툴박스 Tool Box
H009868 370 · 277 · 64



모니터 받침대 Monitor Base
SMP0100OA 734 · 260 · 85
SMP0100SW 734 · 260 · 85
SMP0100PE 734 · 260 · 85



모니터 받침대 Monitor Base
SMP0110 734 · 260 · 85



모니터 받침대 Monitor Base
SMP50006 600 · 310 · 180
SMP50008 800 · 310 · 180

Office Executive

VENEER



KAISER 8100 Group 100



EX9 900 Group 106

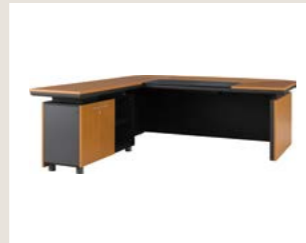

EX8 800 Group 112

LAMINATE



LACUS 6400 Group 118



EX3 301 Group 122



EX3 302 Group 126

KAISER 8100 Group

The harmony of three-dimensional dual structure with modern square type and high-class wenge veneer

모던한 스퀘어 타입의 입체적인 이중구조와 고급스러운 웬지 무늬목의 조화

최고급 '웬지' 무늬목에 다크 그레이를 엠보 도장의 이중 패널 구조로 디자인되어
중후하고 럭셔리한 분위기를 느낄 수 있는 정상급 중역 가구 시리즈입니다.

The elegant and luxurious design is equipped with diverse functions that
match the executive-level furniture and extends the concept of the personal
workplace to the entire area surrounding the desk.



KAISER 8100 Group

중후한 분위기의 회의실에 더욱 잘 어울리는
카이저 시리즈의 컨퍼런스 테이블.

The conference table of Kaiser series harmonize well
with a stately conference room.



KAISER 8100 Group



- 1 주 업무면에 최고급 마이크로 화이버 가죽소재로 마감하여 최상의 감촉을 유지하는 슬라이딩 상판은 편리하고 기능적인 펜트레이가 부착되어 있습니다.
- 2 배선 관리를 위해 회의 테이블에 내장된 스틸소재 멀티탭 홀더.
- 3 스틸 커버의 홈을 이용하여 깔끔한 배선처리가 가능한 상판.(멀티탭 별도)
- 4 한 개의 열쇠로 모든 제품의 잠금 장치를 관리할 수 있는 One Key System과 안전을 고려한 기능적인 Flexible Key.
- 5 다양한 수납공간과 장식을 겸하는 월 캐비닛의 조명장치.
- 6 양면 수납형 서랍 박스는 공간 활용을 높여줍니다.(DD8121A용)

- 1 The main work surface is finished with premium micro-fiber leather to maintain its finest touch; the sliding upper panel is conveniently equipped with a functional pen tray.
- 2 Simple wire management using a groove in the steel cover of the worktop.
- 3 Steel multi-tap holder encased for managing cables on meeting table. (Power Strip must be purchased separately.)
- 4 One Key system: one key can open all the locks; flexible key that is fully functional and designed with safety in mind.
- 5 A variety of storage options; wall cabinet lighting that also serves as decoration.
- 6 Drawer-box with double side access; designed for counselor. (for DD8121A)

KAISER 8100 Group



데스크(기본형)
Desk(Standard Type)
DD8121 2100 · 950 · 730

Color. WE
Page. 108-113



크레덴자 Credenza
CR8121 2166 · 450 · 714

Color. WE
Page. 108-113



캐비닛 Cabinet
BS8108N 800 · 396 · 1930
BS8105(L/R)N 562 · 396 · 1930

BS8105NL Color. WE
Page. 108-113



서랍(기본형)
Drawer(for Standard Desk)
DB8120 400 · 600 · 610
DB8130 400 · 600 · 610

Color. WE
Page. 108-113



사이드 책상 Side Board
SB8114N 1400 · 450 · 670

Color. WE
Page. 108-113



옷장 Wardrobe
BS8105(L/R)N 562 · 396 · 1930

Color. WE
Page. 108-113



캐비닛 Cabinet
WC8128 2850 · 400 · 1952

Color. WE
Page. 108-113



사이드 패널 Side Panel
SP8119 397 · 1930 · T60
탑 패널 Top Panel
TP8128 2850 · 400 · T31

Color. WE
Page. 108-113



회의용 테이블 Conference Table
CT8116R ø1600 · 730

Color. WE
Page. 108-113



회의용 테이블 Conference Table
CT8121 2100 · 1000 · 730

Color. WE
Page. 108-113



차탁자 Tea Table
OT8116 1600 · 750 · 420

Color. WE
Page. 108-113



협탁 Side Table
OT8104 418 · 700 · 505

Color. WE
Page. 108-113



소파 Sofa
OS8110(천연가죽 Genuine Leather)
OS8112(인조가죽 Artificial Leather)
900 · 810 · 850

Color. SG801 / SA801



소파 Sofa
OS7012W 800 · 820 · 760

Color. BK (SA701) / BR (SA703)

EX9 900 Group

The highest class fumigation veneer with luxurious and modern design provides new environment

최고급 훈증무늬목의 고급스러움과 모던한 디자인이 선사하는 새로운 감각

트렌디하면서도 볼륨감 넘치고, 고급스러우면서도 모던한 새로운 감각의 EX9.

기품있는 디자인에 사용 편의성 또한 갖춘 중역용 오피스 가구입니다.

EX9 with trendy, glamorous, luxurious and modern design.

Executive office furniture possessing elegant design and utility.



EX9 900 Group

최고급 훈증무늬목이 사용된 책상과 회의테이블, 크레덴자, 장식장, 옷장 등이 일체감있게 구성되어 기품있고 조화로운 중역 공간을 연출합니다.

The highest class fumigation veneer desk, conference table, credenza, wardrobe provides consistency and harmonious executive work space.



책상 VDD90021D 서랍 VDB90004L 하부장 VRD90018R 캐비닛 VBS90008AG / VBS90006L / VOW90006R
크레덴자 VCR90016 의자 CSOH95052A

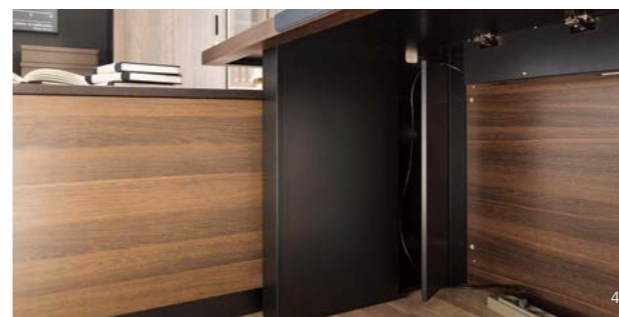

- 1 최고급 훈증 무늬목을 사용하여 책상과 일체감 있게 구성된 회의 테이블
- 2 독일 Mehligs & Weismann의 최고급 건식무늬목에 블랙 캐스팅 다릿발을 적용한 회의 테이블입니다.
- 3 캐비닛 도어를 열 때마다 자동으로 점등되는 센서식 LED 조명등으로 편리합니다.
- 4 책상 다리 내부공간을 활용하여 전선 및 각종 케이블, 외부 전자기기 케이블 등을 효과적으로 정리할 수 있습니다.
- 5 독일 Mehligs&Weismann의 최고급 건식 훈증오르무늬목을 사용하여 압도적인 밸류감과 컬러감을 선사합니다.

- 1 Conference table with the highest class fumigation veneer.
- 2 Conference table with black steel leg and Germany Mehligs & Weismann's the highest class dry veneer.
- 3 Convenient sensor type LED light works whenever cabinet door opens.
- 4 Efficient arrangement use with inner space of table.
- 5 Germany Mehligs & Weismann's the highest class dry veneer provides overwhelming value and color.

EX9 900 Group













- 1 독일 Bachmann社의 전선덕트, 벨기에 Blum社의 힌지, 독일 Hettich社의 언더레일 등 세계적 제조사의 제품을 적용하였습니다.
- 2 무늬목으로 마감한 덕트커버와 Bachmann社의 전선덕트를 사용하여 군더더기 없는 디자인과 기능성을 모두 잡았습니다.
- 3 PC장, 서랍장, 다용도 수납공간까지 넉넉하게 갖추었으며, 댄핑기능이 적용된 서랍, 슬라이딩 도어, 푸쉬도어로 부드러운 사용감을 제공하는 하부장
- 4 상부의 케이블 패스를 활용하여 책상에서 사용하는 전자기기의 케이블도 쉽게 연결할 수 있습니다.
- 5 서랍박스 후면의 푸쉬도어를 사용하여 숨겨진 수납공간을 활용할 수 있습니다.
- 6 책상 위에 거치하고 사용할 수 있는 가죽 데스크패드는 부드러운 마감처리로 사용감이 좋습니다.

- 1 Germany Bachmann's wire duct, Belgium's hinge, Germany Hettich's under rail is applied.
- 2 Veneer finishing duct cover and Bachmann's wire ducts provide clean design and utility.
- 3 Lower cabinet including PC storage, cabinet, multi-use storage provides soft closing with damping function.
- 4 Easy cable connecting with cable pass in upper board.
- 5 Drawer provides hidden space with push door.
- 6 Leather desk pad provides soft touching.

EX9 900 Group

Color / Material	OA(V901) VENEER	OA(L901) LPM	UT LPM *출시예정
------------------	-----------------	--------------	--------------

	데스크 Desk VDD90021D 2100 · 900 · 750 Color . OA(V901) / OA(L901)		회의용 테이블 Conference Table VCT90022SL 2200 · 1000 · 720 VCT90022 2200 · 1000 · 750 Color. OA(V901) / OA(L901)
	3단 서랍 3-Level Drawer VDB90004L(R) 398 · 776 · 602 Color. OA(V901) / OA(L901)		하부장 Lower Part Storage VRD90018L(R) 1860 · 500 · 602 Color. OA(V901) / OA(L901)
	크레덴자 Credenza VCR90016 1600 · 400 · 738 Color. OA(V901) / OA(L901)		데스크패드 Desk Pad VDP900BK 800 · 515 · 50 Color. BK
	캐비닛 Cabinet VBS90006L(R) 600 · 400 · 1925 Color. OA(V901) / OA(L901)		옷장 Wardrobe VOW90006L(R) 600 · 400 · 1925 Color. OA(V901) / OA(L901)
	유리도어 캐비닛 Glass Door Cabinet VBS90008AG 800 · 400 · 1925 Color. OA(V901) / OA(L901)		

EX8 800 Group

The sensitive design with flexible curve,
stately atmosphere

유연한 곡선을 살린 감성적인 디자인, 중후한 분위기

고급가구에만 사용하는 '티크' 무늬목에 깊이감 있는 다크 그레이의 투톤 컬러로 매치시켜 중후하고 우아한 분위기를 느낄 수 있는 EX8 800 시리즈.

The EX8 800 Series, made with teak veneer, which is used only in high-end furniture, matched with deep dark gray, creates a dignified and elegant atmosphere.



*형식상 좌형(의탁 포함) VD80021, 익스텐션 좌형 VRC80021L, 3단서랍박스 VDB80030
유리도어 캐비닛 VBS80003, 캐비닛 우형 VBS80005R, 옷장 좌형 VOW80005L, 회의테이블 VCT80022, 2100 크레덴자 VCR80021

EX8 800 Group

부드럽게 꺾어지는 라운드 엣지와 티크 무늬목의 고급스러운 조화가 돋보이는 디자인.
The design conspicuous with the high-class harmony of gently folded round edge and teak veneer.



책상(덕트 포함) VDB80021 3단서랍박스 VDB80030 유리도어 캐비닛 VBS80008 캐비닛 우형 VBS80005 옷장 좌형 VOW80005 2100 크레덴자 VCR80021



회의테이블 VCT80022 유리도어 캐비닛 VBS80008 캐비닛 우형 VBS80005R 옷장 좌형 VOW80005L 2100 크레덴자 VCR80021



- 1 캐비닛과 옷장은 넓고 다양하게 공간 활용에 용이하며, 스무브힌지로 부드러운 도어 닫힘을 느끼실 수 있습니다.
- 2 인조가죽 마감 패널이 슬라이딩 구조로 패널을 열어 5구 멀티플러그, LAN, USB 단자를 활용할 수 있고 미 사용시 패널을 닫아 깔끔하게 사용할 수 있습니다.
- 3 크레덴자는 서류나 책 등의 아이템을 정리할 수 있는 내부수납, 인테리어 소품 등을 올려놓을 수 있는 외부 수납이 가능합니다.
- 1 Cabinet and wardrobe provides wide and various space usage and smooth door closing with smooove hinge.
- 2 Sliding construction, artificial leather finish panel contains 5 hole multi plug, LAN and USB functions in it.
- 3 Credenza is available for both internal storage for documents and external storage for interior decoration.

- 4 티크 무늬목과 다크 그레이가 조합된 다릿발은 고급스러운 느낌과 함께 세련된 느낌을 선사합니다.
- 5 회의 테이블 다릿발은 고급소재인 알루미늄 다이캐스팅 소재와 블랙 분체 도장으로 중후한 느낌을 보여줍니다. 또한 레벨러가 설치되어 수평조절에도 편리합니다.
- 6 블랙과 티크의 투톤의 볼륨감 있는 상판으로 더욱 고급스러운 느낌을 주며, W2100xD1000의 넓은 사용공간으로 공간활용에 용이합니다.
- 4 Harmony of teak veneer and dark gray leg provides elegant and sophisticated mood.
- 5 Aluminum die-casting and black painting finish shows dignity. Also, provides easy horizontal control with leveler.
- 6 Upper board with black and teak two tone color provides more luxurious mood and W2100 x D1000 size suggests wide space usage.

EX8 800 Group

넓고 다양한 수납공간 아이템 조합으로 더욱 품격있는 공간을 만들어 주는 EX8 800 Group.

EX8 800G suggests more elegant space by providing various storage item combination.



인조가죽 1인소파 VOS80010A 3인소파 VOS80030A 협탁 VOT80004 차탁자 VOT80016



1



2

- 1 볼륨감 있는 등판은 사용자에게 편안한 느낌을 주며, 원목팔걸이는 차를 마시거나 간단한 메모가 가능합니다.
 - 2 차탁자 하부의 별도 수납공간이 있어 잡지, 신문 등 공간 활용에 용이합니다.
- 1 Soft back board is comfortable and wood armrest is available for putting cups or papers.
- 2 Tea table contains extra storage.

EX8 800 Group

Color / Material	T(V802) VENEER	SG801 GENUINE LEATHER	SA801 ARTIFICIAL LEATHER
------------------	----------------	-----------------------	--------------------------



데스크(기본형) Desk(Standard Type)
VDD80021D 2080 · 1050 · 730
VDD80021(L/R)D 2080 · 2250 · 730



VDD80021L

Color. T



VRD80021L

익스텐션 Extention
VRD80021(L/R) 2052 · 540 · 730

Color. T



서랍(기본형) Drawer(for Standard Desk)
VDB80020 400 · 600 · 610
VDB80030 400 · 600 · 610

Color. T



크레덴자 Credenza
VCR80021 2124 · 453 · 716

Color. T



협탁 Side Table
VOT80004 418 · 700 · 505

Color. T



캐비닛 Cabinet
VBS80008AGTK 800 · 396 · 1930
VBS80005(L/R) 562 · 396 · 1930

VOW80005L

Color. T



옷장 Wardrobe
VOS80005(L/R) 562 · 396 · 1930

VOW80005L

Color. T



회의용 테이블 Conference Table
VCT80022 2200 · 1000 · 720

Color. T



차탁자 Tea Table
VOT80016 1600 · 750 · 420

Color. T



소파 Sofa
1인소파 1 Person
VOS80010A 900 · 810 · 850
3인소파 3 Person
VOS80030A 1900 · 810 · 850



Color. SG801 / SA801

Executive Veneer EX8 800 Group

LACUS 6400 Group

The harmonious design and style with the new structure and various materials



데스크 DD6419 익스텐션 AD6412 서랍 DB6420
크레덴자 CR6414 캐비닛 BS6409A 옷장 OW6406R

LACUS 6400 Group















LACUS 6400 Group

Color / Material		
	N(H641) HPM	UT LPM *출시예정



- 1 기품있는 노체컬러와 알루미늄, 직선과 곡선이 조화되어 세련미를 느낄 수 있습니다.
- 2 깔끔한 배선처리가 가능한 상판.
- 3 책장 알루미늄 프레임 모서리의 보호용 코너캡.
- 4 모던하고 세련된 알루미늄 브라켓은 내구성이 강하고 견고함.

- 1 Classy noce colors and aluminum, curved and straight lines in harmony-Lacus.
- 2 Desk Top designed for effective wire management.
- 3 Bookshelf corner cap for the aluminum frame.
- 4 Modernized and classy aluminum brackets are durable and solid.

	데스크 Desk DD6419N 1900 · 1000 · 730		익스텐션 Extension AD6412N 1200 · 550 · 730
Color. N		Color. N	
	사이드 책상 Side Desk RD6412N 1200 · 550 · 730		컴퓨터 책상 Computer Desk CD6409N 900 · 740 · 730
Color. N		Color. N	
	2단 서랍 2-Level Drawer DB6420N 431 · 600 · 603		3단 서랍 3-Level Drawer DB6430N 431 · 600 · 603
Color. N		Color. N	
	크레덴자 Credenza CR6414N 1440 · 400 · 750		회의용 테이블 Conference Table CT6418N 1800 · 950 · 730 CT6421N 2100 · 1100 · 730
Color. N		Color. N	
	캐비닛 Cabinet BS6409N 900 · 400 · 1950		캐비닛 Cabinet BS6409AN 900 · 400 · 1950
Color. N		Color. N	
	책장 Bookshelf BS6406(L/R)N 600 · 400 · 1950		옷장 Wardrobe OW6406(L/R)N 600 · 400 · 1950
Color. N		Color. N	
	차탁자 Tea Table OT6415N 1500 · 700 · 450 OT6421N 2100 · 750 · 450		협탁 Side Table OT6404N 450 · 700 · 500
Color. N		Color. N	
	전화대 Telephone Table TT6404N 450 · 600 · 650		
Color. N			

Executive
Laminate
LACUS 6400 Group

EX3 301 Group

The class that emanates from natural teakwood,
a trend of high end classic executive furniture

내추럴 티크의 깊은 품격, 고급 중역가구의 고전적 트렌드

세계 4대 무늬목 중 가장 은은하고 결이 고운 티크 내추럴 무늬목으로
마감처리되어, 격조 높은 공간을 꾸며 드리는 EX3 301 Group.
하이 엔드 사무가구의 고전적인 트렌드로 자리잡고 있습니다.

The EX3 301 Group is polished with a subdued and beautiful
teakwood veneer and enhances the prestige of your office.
It is a mainstay in the trend of high end classic executive furniture.



EX3 301 Group



캐비닛 VBS30108G 옷장 VOW30105R

1



2











3

4

- 1 용도와 기능에 따라 다양한 공간 활용이 가능한 옷장.
 - 2 데스크와 회의테이블 상판에 전선덕트를 내장하여 깔끔한 배선처리가 가능합니다.(알루미늄 전선덕트 커버)
 - 3 한 개의 열쇠로 모든 제품의 잠금장치를 관리할 수 있는 One Key System과 안전을 고려한 기능적인 Flexible Key를 갖추었습니다.
 - 4 깔끔한 배선처리가 가능한 상판.
- 1 Closet for various functions and uses.
 - 2 Clean wiring with the wire duct embedded in the work surface of the conference table and desk (aluminum wire duct cover).
 - 3 One key system: one key can open all the locks; flexible key that is fully functional and designed with safety in mind.
 - 4 The cable management system keeps the desk tidy.

EX3 301 Group

Color / Material	TE(H3011) HPM	BR(SA7011) ARTIFICIAL LEATHER	IV(SA707) ARTIFICIAL LEATHER

<p>데스크 Desk VDD30120 2032 · 865 · 750</p>  <p>Color. TE</p>	<p>익스텐션 Extension VRD30112 1200 · 550 · 750</p>  <p>Color. TE</p>
<p>서랍 Drawer</p> <p>2단 2-Level VDB30120 402 · 595 · 639</p> <p>3단 3-Level VDB30130 402 · 595 · 639</p> <p>Color. TE</p> 	<p>크레덴자 Credenza VCR30118 1800 · 400 · 750</p>  <p>Color. TE</p>
<p>회의용 테이블 Conference Table VCT30124 2400 · 1000 · 750</p>  <p>Color. TE</p>	<p>캐비닛 Cabinet VBS30105(L/R) 560 · 416 · 1871 VBS30108G 800 · 418 · 1871</p>  <p>Color. TE</p>
<p>옷장 Wardrobe VOW30105(L/R) 560 · 416 · 1871</p>  <p>Color. TE</p>	<p>차탁자 Tea Table VOT30116 1600 · 750 · 420</p>  <p>Color. TE</p>
<p>협탁 Side Table VOT30104 450 · 700 · 500</p>  <p>Color. TE</p>	<p>소파 Sofa SAO70110 780 · 760 · 580</p>  <p>*인조가죽 Artificial Leather Color . BR(SA7011) / IV(SA707)</p>

Executive
Laminate
EX3 301 Group

EX3 302 Group

Clean white images, a forward looking design

화이트의 정갈한 이미지, 앞서가는 미래형 디자인

어둡고 중후한 분위기의 기존 중역가구와 달리 깔끔한 화이트 컬러에 고급스러운 내추럴 패턴을 조화시켜, 미래형스타일의 밝고 화사한 분위기를 느낄 수 있는 EX3 302 Group. 중역가구의 고정화된 기존 틀을 과감하게 탈피한 신개념 중역가구입니다.

The EX3 302 Group offers an alternative look that differs from the dark and serious feel of conventional executive furniture. It matches classy natural pattern with white colors to create a forward looking bright atmosphere to your office. We broke away from convention to create a new concept for executive furniture.



EX3 302 Group



데스크 VDD30219ANL 크레덴자 VCR30218N
캐비닛 VBS30205N / VWC30212N / VOW30205



- 1 월캐비닛에 함께 적용되는 옷장. 코트나 양복 상의를 깔끔하게 수납합니다.
- 2 책상의 가림판은 하프 사이즈로 마감되어 답답하지 않고 시원하면서도 세련된 분위기를 느낄 수 있습니다.
- 3 사이드장은 슬라이딩 아웃도어와 슬라이딩 인도어를 적용하여 수납공간을 다양화하여 깔끔한 디자인이 돋보입니다.
- 4 알루미늄과 스틸 프레임의 매치로 세련된 분위기를 느끼실 수 있습니다.
- 5 손잡이를 노출시키지 않고 기능성과 효율성을 극대화시킨 미니멀리즘 디자인의 도어.
- 6 사이드장 내부에 전선덕트를 내장시켜 전선노출을 최소화하여 전선사용이 편리합니다.

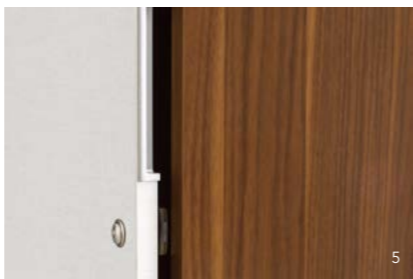

- 1 Closet in the wall cabinet for storing jackets, etc.
- 2 Half-sized desk panel gives an airy, open sophistication to the space.
- 3 Side cabinet has sliding doors and diversified storage units with clean design lines.
- 4 The harmony between aluminium parts and steel frames intensifies the elegance of the product.
- 5 Minimalist door design maximizes functionality and efficiency.
- 6 Side cabinet storage for cable ducts ensures a tidier space.

EX3 302 Group

Color / Material	NE(H3021) HPM	WH(L3022) LPM	BR(SA7011) ARTIFICIAL LEATHER	IV(SA707) ARTIFICIAL LEATHER
------------------	---------------	---------------	-------------------------------	------------------------------



양수책상 Double Pedestal Desk
VDD30219N 1900 · 800 · 750

Color. NE / WH



VRD30216L

익스텐션 Extension
VRD30216B(L/R) 1600 · 590 · 462

Color. NE / WH



VDD30219ANL

L형 데스크 L Type Desk
VDD30219AN(L/R) 2100 · 1600 · 750

Color. NE / WH



크레덴자 Credenza
VCR30218N 1600 · 396 · 720

Color. NE / WH



회의용 테이블 Conference Table
VCT30221 2100 · 1000 · 750

Color. NE / WH



서랍 Drawer
2단 2-Level
VDB30220N 400 · 500 · 651
3단 3-Level
VDB 30230N 400 · 500 · 651

Color. NE / WH



차탁자 Tea Table
VOT30216 1600 · 750 · 420

Color. NE / WH



협탁 Side Table
VOT30204N 450 · 700 · 500

Color. NE / WH



책장 Bookshelf
VBS30205N(L/R) 560 · 396 · 1600

VBS30205NL

Color. NE / WH



옷장 Wardrobe
VOW30205N(L/R) 560 · 396 · 1600

VOW30205NR

Color. NE / WH



월캐비닛 Wall Cabinet
VWC30212N 1200 · 396 · 1600

Color. NE / WH



캐비닛 선반 Cabinet Shelf
VDS30206(1EA) 550 · 240 · 15

Color. NE / WH

Executive

Laminate

EX3 302 Group

Office TABLE

CONFERENCE



EC9 900 Group 132



HC7 700 Group 136



HC7 700 Group 140



HC5 500 Group(독립형) 144



HC5 500 Group(조합형) 148

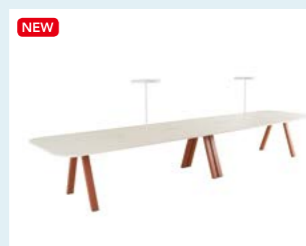

Hub-T 152



CT2000 Group 158

SEMINAR



SWING 160



CLECS 162



PC TABLE 164

EC9 900 Group

Functionality that meets the standards of the era of globalization, and an individualistic feel

국제화 시대에 걸맞은 수준 높은 기능성, 개성있는 분위기

깊이 있고 중후한 컬러로 편안한 회의실을 완성시켜주는 EC9 900 Group
사용자의 편의를 최우선으로 한 최고 사양으로 국제화 수준에 걸맞은 회의용 테이블입니다.
EC9 900Group completes comfortable conference room with
dark color. International standard conference table with best materials.



EC9 900 Group

중후하고 고급스러운 분위기로 임원회의실 등에 잘 어울리는 EC9 900 Group. 어떤 크기의 장소에서도 가장 적합한 구조로 구성할 수 있는 시스템 회의용 테이블입니다.

Perfect for executive conference rooms, the Neoce conference tables create a dignified and luxurious atmosphere.

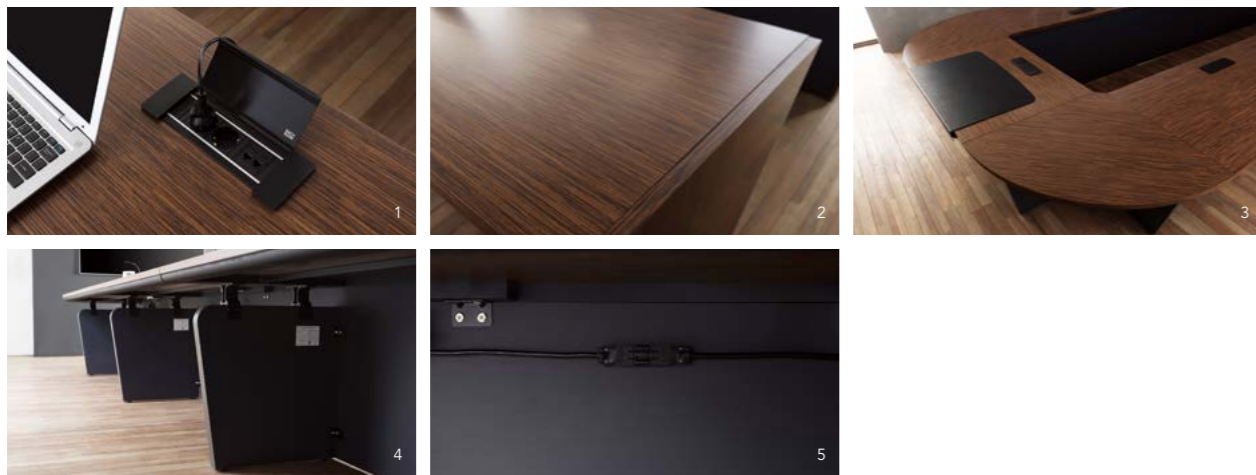

- 1 빠르고 원활한 회의 진행을 위해 독일 Bachmann 사의 전선 덕트를 사용하였습니다.
- 2 EC9 900 Group의 veneer 무늬목 다리는 양쪽 끝에 배치되어 마감패널 역할을 해줍니다.
- 3 코너 상판은 레이아웃에 맞춰 조합할 수 있도록 85도와 90도 타입으로 구성되어 있습니다.
- 4 조합형 테이블의 연결부에 위치한 중간 다리발은 알루미늄 브라켓과 조합하여 상판을 견고하게 지탱해줍니다.
- 5 책상 다리 상부공간을 활용하여 전선 및 각종 케이블을 효과적으로 정리할 수 있으며, 점프케이블을 내장하여 전선 덕트 간 연결을 용이하게 할 수 있습니다.

- 1 Bachmann Co., duct is used for quick and efficient conference.
- 2 EC9 900G's veneer leg functions as finish panel.
- 3 Corner board is consisted with two types 85° and 90° for various layout.
- 4 Legs connect combination table and support upper board firmly with aluminum bracket.
- 5 Upper space of leg is efficient for cable arrangement and includes jump cable.

EC9 900 Group

Color / Material
WE(V811)
VENEER



중역 회의 테이블 Executive Conference System

1000 회의 테이블 1000
Conference System(Veneer)
VCT90010ED 엔더 멀티에더 Adder Multi
VCT90010AD 엔더 멀티 Ender Multi
1000 · 750 · 712

Color. WE



1600 회의 테이블 1000
Conference System(Veneer)
VCT90016AD 엔더 멀티에더 Adder Multi
VCT90016ED 엔더 멀티 Ender Multi
1600 · 750 · 712

Color. WE



2200 회의 테이블 1000
Conference System(Veneer)
VCT90022AD 엔더 멀티에더 Adder Multi
VCT90022ED 엔더 멀티 Ender Multi
2200 · 750 · 712

Color. WE



중역 회의 테이블 Executive Conference System

코너형 Corner Type
VCT90090 800 · 800 · T50(90°)
VCT90085 800 · 800 · T50(85°)

Color. WE

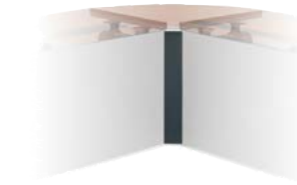

연결패널 Panel for Connection
VCPCA90090(90°)
VCPCA90085(80°)



중역 회의 테이블 Executive Conference System

다리(마감형) Leg(End Type)
VCL900E(L/R) 750 · T50 · 712

Color. WE



다리(중간형) Leg(Middle Type)
VCL900C 580 · T48 · 590



수평덕트 Horizontal Duct
VHD90010(for VCT90010)
VHD90016(for VCT90016)
VHD90022(for VCT90022)

HC7 700 Group

The simple structure for extension and modification,
modern minimalism design

확장과 변이가 용이한 구조, 모던한 미니멀리즘 디자인

심플한 컨템퍼러리 디자인에 회의공간의 크기에 따라 쉽게 확장할 수 있는 기능을 갖춘 회의용 테이블. 내추럴과 화이트의 두 가지 컬러로 분위기에 따라 색상 선택이 가능합니다.

A clean, contemporary design easily adapted to any size space.
Color choice between natural wood and white.



HC7 700 Group



기본형 VCT70024F 중앙확장형 VCT70024M



2



3

- 1 심플한 분위기의 HC7 회의용 테이블은 공간의 크기에 따라 원하는대로 확장하여 설치할 수 있는 전개형 시스템 테이블입니다.
- 2 알루미늄 양문형 덕트 콘센트는 랜포트, USB 2port, 4구 콘센트 사용이 가능합니다. (옵션 항목 : 블랙, 화이트)
- 3 심플하면서도 견고하게 체결되어 흔들림 없이 지지해주는 하부 받침대.

- 1 The HC7 conference table allows you to install or expand the conference table according to your preferences.
- 2 This aluminum double-door duct socket-outlets are available with LAN port, USB 2 port, and 4 sockets-outlet (option : black, white)
- 3 A simple lower stand that supports the table and prevents wobbling.

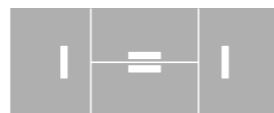

4000×1600×730

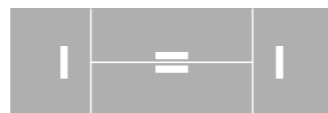

4800×1600×730



HC7 700 Group

Color / Material		
	ZE(V7001) VENEER	WH(V7003) PAINTING

기본형 General Type
VCT70024F 2400 · 1600 · 730
(2ea / 1 set)



4000×1600×730

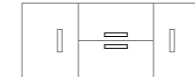

Color. WH / ZE

중앙 확장형 Central Extended Type
VCT70016M 1600 · 1600 · 730
VCT70024M 2400 · 1600 · 730



4800×1600×730



Color. WH / ZE

HC7 700 Group

We shall open a forward looking creative space
for the global era

글로벌 시대의 '미래 창조 공간'을 열어줍니다

글로벌 시대에 어울리는 첨단 디자인 감각과 매립형 전선 덕트 등 뛰어난
기능성으로 회의실을 '미래 창조 공간'으로 꾸며드리는 HC7 시리즈.
화이트와 내추럴 등 2종류의 컬러를 갖추고 있어 원하는 분위기의 회의 공간을
선택하여 꾸밀 수 있습니다.

The HC7 series creates a forward looking creative space with a cutting edge
design and excellent functionality. You can choose between 2 colors, white or
natural. You can choose to create the conference room that you desire.



HC7 700 Group

대형 회의실에 잘 어울리는 시스템 회의용 테이블. 글로벌 시대에 적합한 세련된 디자인과 공간의 크기에 꼭 맞게 설치할 수 있는 모듈형 회의테이블입니다.

Sophisticated, modular meeting tables transform any conference or meeting room into the ultimate functional and modern space.



- 1 마감 측면은 오픈시키지 않고 깔끔한 아크릴로 마감하였습니다.
- 2 코너에 부착, 마감되는 애더와 엔더 또한 다리와 동일한 스테인레스 스틸로 제작되어 통일감을 살렸습니다.
- 3 알루미늄 양문형 덕트 콘센트는 랜포트, USB 2port, 4구 콘센트 사용이 가능합니다. (옵션 항목 : 블랙, 화이트)
- 4 테이블의 하부가림판은 깔끔하고 슬림한 형태의 아크릴 가림판을 부착하여 더욱 세련된 이미지를 연출합니다
- 5 고급스러운 스테인레스 스틸로 제작된 다리. 조형미를 느낄 수 있는 형태에 사용자와의 간섭을 최소화시킨 디자인입니다.

HC7 700 Group

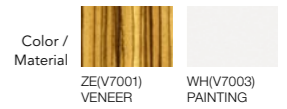

스타터(상석) Starter(Head Table)
U형 상석
U Type Head Table
 VAT70022U 2200 · 750 · 720
V형 상석
V Type Head Table
 VAT70022V 2200 · 750 · 720

Color. ZE / WH



코너 애더 Corner Adder
 VAT70023C(L/R) 2290 · 750 · 720

Color. ZE / WH



애더 Adder
 VAT70016A 1690 · 750 · 720
 VAT70024A 2490 · 750 · 720

Color. ZE / WH



엔더 Ender
 VAT70016E(L/R) 1600 · 750 · 720
 VAT70024E(L/R) 2400 · 750 · 720

Color. ZE / WH



마감 측면 Finished Side Panel
 VSP70075 750 · 707 · 30
 (2ea / 1 set)

Color. ZE / WH



모듈 기본형 Basic Module
 VAT70045O 4500 · 2300 · 720

Color. ZE / WH

- 1 Side panel closed with clean acrylics.
- 2 Corner adders/enders made with stainless steel for design cohesiveness.
- 3 This aluminum double-door duct socket-outlets are available with LAN port, USB 2 port, and 4 sockets-outlet (option : black, white)
- 4 Clean and slim lower panel presents a more sophisticated look.
- 5 Stainless steel legs and formative design principles ensure less interference between users.

HC5 500 Group (독립형)

The practical conference table available for various meeting space with trendy design

트렌디한 디자인과 다양한 회의공간에 배치가능한 실용적인 회의테이블

밝고 화사한 느낌으로 유쾌한 소통의 공간으로 회의시간을 바꾸어 드립니다.

독립형 모듈로 구성되어 6인용부터 16인용까지 공간의 크기에 맞게 구성, 배치할 수 있어 소규모 회의실 뿐 아니라 대형 중역회의실까지 다양한 회의실을 연출할 수 있습니다.

With a bright beautiful atmosphere the package delivers, the set helps transform business meetings into hours of pleasant communication between people. Independent modules can easily accommodate the needs for a meeting of 6 to 16 people. Thus the package is suited not just to a small meeting room but also to large-scale executive conference halls.



HC5 500 Group (독립형)



- 1 사용자의 움직임을 배려한 디자인으로 다리 걸림 최소화.
- 2 고급스러운 소재 알루미늄 캐스팅으로 샤프한 느낌을 부여하며, 글라이더로 높이 조절 가능.
- 3 알루미늄 양문형 덕트 콘센트는 랜포트, USB 2port, 4구 콘센트 사용이 가능합니다.
(옵션 항목 : 블랙, 화이트)

- 1 The user-centered design ensures users' restriction-free leg movement under the table.
- 2 Aluminium casting of top-tier materials guarantees stylishness, with gliders enabling height adjustment.
- 3 This aluminum double-door duct socket-outlets are available with LAN port, USB 2 port, and 4 sockets-outlet (option : black, white)

HC5 500 Group (독립형)

Color / Material	SW(H701) HPM	EL(H702) HPM
------------------	--------------	--------------



단독형 Single Type
 CCT50020 2000 · 1200 · 730
 CCT50020D 2000 · 1200 · 730
 6인용 for 6 persons

Color. SW / EL



단독형 Single Type
 CCT50024 2400 · 1200 · 730
 CCT50024D 2400 · 1200 · 730
 8인용 for 8 persons

Color. SW / EL



연결형 Connecting Type
 CCT50032 3200 · 1200 · 730
 CCT50032D 3200 · 1200 · 730
 10인용 for 10 persons

Color. SW / EL



연결형 Connecting Type
 CCT50040 4000 · 1200 · 730
 CCT50040D 4000 · 1200 · 730
 12인용 for 12 persons

Color. SW / EL



연결형/확장형 Connecting Type / Adder Type
 CCT50048 4800 · 1200 · 730
 CCT50048D 4800 · 1200 · 730
 14인용 for 14 persons

Color. SW / EL



연결형/확장형 Connecting Type / Adder Type
 CCT50056 5600 · 1200 · 730
 CCT50056D 5600 · 1200 · 730
 16인용 for 16 persons

Color. SW / EL

CCT50008 800 · 1200 · 730
 CCT50048 사용자추가 옵션사양
 An option item for CCT50048

- CCT500** 덕트커버(O) / 하부덕트(O) / 기능형멀티탭(x)
 Duct Cover (O) / Under-the-desk Duct (O) / Functional Multi-tab (x)
- CCT500**D 덕트커버(O) / 하부덕트(O) / 기능형멀티탭(O)
 Duct Cover (O) / Under-the-desk Duct (O) / Functional Multi-tab (O)

HC5 500 Group (조합형)

HC5 enhances the value of communication in meetings of various types

HC5는 회의공간에서의 소통의 가치를 높입니다

자유로운 소통환경을 위한 자유로운 레이아웃 배치와 조합구성으로 회의실의 크기와 구조에 제약받지 않는 효율을 주며 차별화된 디자인으로 특별한 회의실을 구현합니다.

The overall layout of conference tables can be changed easily through a diverse combination of individual tables. The user no longer needs to be restrained due to the size and other characteristics of his/her conference rooms.



스타터 CAT50016S 애더 CAT50016A 코너형애더 CAT50020CA(L/R) 상석애더 CAT50020VA 엔더 CAT50016E
사이드가림판 CSP50065LR 스크린 CSP50016 / CSP50013C / CSP50006 콘센트 FMT70020L

HC5 500 Group (조합형)

회의실 시스템 모듈구성 Conference System Module

- ① 테이블-일자형 Straight Ender
- ② 테이블-일자형 Straight Adder
- ③ 테이블-코너형 Corner Adder - R Type
- ④ 상석테이블-V자형 V-shape Adder
- ⑤ 테이블-코너형 Corner Adder - L Type
- ⑥ 테이블-일자형 Straight Starter
- ⑦ 테이블-일자형 Straight Stand-alone
- ⑧ 테이블-코너형 Corner Ender
- ⑨ 테이블-코너형 Corner Starter
- ⑩ 상석테이블-U자형 U-shape Adder

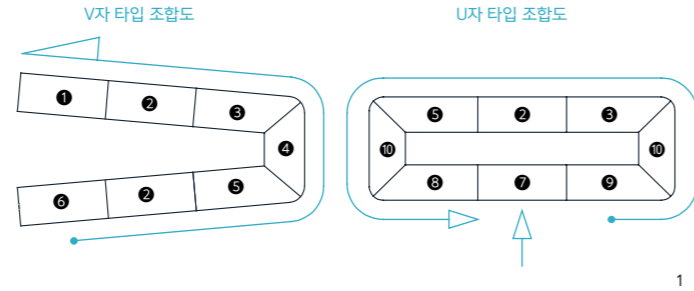















- 1 유닛으로 구성된 시스템 컨퍼런스 테이블로 공간의 크기에 꼭 맞게 구성, 배치할 수 있습니다.
- 2 다리걸림이 최소화될 수 있도록 디자인된 다이캐스팅 다릿발은 사용자의 움직임의 활동폭이 넓게 배려하였습니다.
- 3 바닥에서 전원이 연결되는 수직덕트는 메탈실버로 마감되어 전체 분위기와 잘 어울립니다.
- 4 상판 위에 연결하여 사용할 수 있는 콘센트로 멀티미디어 기기 사용에 최적의 사용성을 제공합니다.
- 5 V자형 타입에 적용된 사이드 가림판은 개인 프라이버시 및 회의실의 웅장함을 더할 수 있습니다.

- 1 The unit-based conference system table enables the user to create a conference environment best suited to the size of the given space.
- 2 The die-cast table legs are designed to prevent the user from stumbling into it and maximize his/her freedom of movement.
- 3 The vertical cable duct is connected to power on the floor. Its metallic silver color finish perfectly matches the overall atmosphere of the conference system.
- 4 A movable socket placed on the table enables the user to tap into a variety of multimedia devices at the same time.
- 5 The side screen used for a V-shape table arrangement not only enhances the user's privacy but also adds to the integrity of the entire conference room.

HC5 500 Group (조합형)

Color / Material	상판 Desk	하부가림판
SW(H701) LPM	EL(H702) LPM	GRAY(PF75)

 <p>테이블 - 일자형 Table - Straight Type 스타터 Starter CAT50008S 800 · 650 · 730 CAT50012S 1200 · 650 · 730 CAT50016S 1600 · 650 · 730</p> <p>Color. SW / EL</p>	 <p>테이블 - 일자형 Table - Straight Type 애더 Adder CAT50008A 800 · 650 · 730 CAT50012A 1200 · 650 · 730 CAT50016A 1600 · 650 · 730</p> <p>Color. SW / EL</p>
 <p>테이블 - 일자형 Table - Straight Type 엔더 Ender CAT50008E 800 · 650 · 730 CAT50012E 1200 · 650 · 730 CAT50016E 1600 · 650 · 730</p> <p>Color. SW / EL</p>	 <p>테이블 - 일자형 Table - Straight Type 독립형 Stand-alone CAT50008F 800 · 650 · 730 CAT50012F 1200 · 650 · 730 CAT50016F 1600 · 650 · 730</p> <p>Color. SW / EL</p>
 <p>테이블 - 코너형 Table - Corner Type 스타터 Starter CAT50020CSL(L) 1877 · 650 · 730</p> <p>Color. SW / EL</p>	 <p>테이블 - 코너형 Table - Corner Type 애더 Adder CAT50020CA(L/R) 1877 · 650 · 730</p> <p>Color. SW / EL</p>
 <p>테이블 - 코너형 Table - Corner Type 엔더 Ender CAT50020CER(R) 1877 · 650 · 730</p> <p>Color. SW / EL</p>	 <p>테이블 - 코너형 Table - Corner Type 1/4 원 코너 애더 1/4 Circle Shape Corner Adder CAT50065R 650 · 650 · 730</p> <p>Color. SW / EL</p>
 <p>U자형 상석테이블 U Shape Head Table 애더 Adder CAT50020UA 1754 · 650 · 730</p> <p>Color. SW / EL</p>	 <p>V자형 상석테이블 V Shape Head Table 애더 Adder CAT50020VA 1649 · 650 · 730</p> <p>Color. SW / EL</p>
 <p>테이블 스크린(하부가림판) Table Privacy Screen(Blocks Upper Side) CSP50006 상석 테이블용 for Table or Top Seat CSP50013C 코너용 for Corner Table CSP50008 W800용 for W800 CSP50012 W1200용 for W1200 CSP50016 W1600용 for W1600</p> <p>Color. PE75</p>	 <p>사이드 가림판(V자형용 측면가림판) Table Privacy Screen (Side Screen for V Shape) CSP50065LR(L/R 1 set)</p> <p>Color. SE / EL</p>
 <p>악세서리 Accessories 전선 덕트 Cable Duct JD1000</p>	 <p>콘센트 Socket 2구 2 Socket FMT70020L(2LAN) FMT70020U(2USB) FMT70020UL(2LAN/2USB) 3구 3 Socket FMT70030L(2LAN) FMT70030U(2USB) FMT70030UL(2LAN/2USB) 4구 4 Socket FMT70040L(2LAN) FMT70040U(2USB) FMT70040UL(2LAN/2USB)</p>

Hub-T^{NEW}

We pursue smart and flexible communication

스마트하고 유연한 커뮤니케이션을 추구합니다

자유로운 스마트 워킹을 추구하고 있는 트렌드에 맞추어 오픈 커뮤니케이션에 적합한 오피스 레이아웃을 추구합니다. 디테일한 소품 하나하나까지 더 고민하여 사용자에게 최상의 솔루션을 제공해드립니다.

In line with the trends of free smart working, we pursue an office layout suitable for open communication. We consider every detail with accessories and provide customers with the best solution.



Hub-T

확장 및 추가 구성이 가능하며 합리적인 가격과 디자인의 모듈형 테이블로
변동좌석제 오피스 직군 또는 회의실 공간, 라운지 빅테이블로 활용이 가능합니다.

This modular table is expendable and addable with other items, and have
reasonable price. It can be utilized as changeable seating system office group,
meeting room space, or lounge big table.



팀테이블 H010744 T 조명 H009743 의자 H010691



2



- 1 W2000 기본형 테이블 양 옆으로 W400mm 라운드형 확장상판을 연장할 수 있습니다.
- 2 알루미늄 양문형 덕트 콘센트는 5구 콘센트, 1 LAN(추가 1 port 옵션), USB 2 port(옵션) 사용이 가능합니다. (옵션 항목 : 블랙, 화이트)
- 3 기동(bar)을 터치하여 조명을 켜고 끌 수 있으며, 3단계 밝기조절이 가능합니다. 플랫한 디자인과 상판기준 700mm 높이의 하이탑 조명 방식으로 소통 시 간섭을 최소화하였습니다. (옵션 항목 : 블랙, 화이트)
- 4 다릿발 바닥면 레벨러 적용하여 제품 설치 환경에 따라 수평을 맞추고 흔들림을 방지합니다.
- 5 사용자의 착석 형태에 따라 이동형 사이드스크린을 원하는 위치에 설치하고 제거하여 공간을 분리해서 사용할 수 있습니다. (옵션)
- 6 다릿발은 직사각 사선 구조의 안정적인 디자인으로 오랜 기간을 사용해도 선반 꺼짐 없이 사용할 수 있도록 하부 구조를 보강하였습니다.

- 1 You can extend this 2000 basic table on either side of it with 400mm round expandable upper board.
- 2 This aluminum double-door duct socket-outlets are available with LAN port, USB 2port, and 4 sockets-outlet (option : black, white)
- 3 You can turn on/off the light by touching the bar, and adjust the brightness at desired level through 3 stages. The flat design and the high top lighting method of 700mm height based on the upper board minimize the interference when communicating. (option: black, white)
- 4 The leg leveler keeps the surface of your table horizontal and to prevent it from wobbling.
- 5 According to the user's seating type, the movable side screen can be installed and removed at the desired position to separate the space. (option)
- 6 The legs have stable rectangular diagonal design and are reinforced so that this table can be used without hollowed shelf even after a long period of use.

Hub-T

Hub-T는 2000, 2800, 4000, 4800 등 자유롭게 사이즈 확장 가능합니다. 모듈화된 구성으로 벤치형 데스크, 회의용 테이블, 빅테이블 등 용도에 따른 제거와 추가가 편리합니다.

The HC 300G can be freely scaled to 2000, 2800, 4000, or 4800. Modular configuration makes it easy to remove and add bench-type desks, conference tables, and big tables.

A Type

사이즈 : W2000 x D1200 x H730(조명 제외)
 구성 : W2000 상판 + 보강바
 조립 방법 : 다리발 양쪽 내측 결합

Size : W2000 x D1200 x H730(Light Excluded)
 Composition : W2000 Top Panel + Assist Beam
 Assembling method : Joining on both inner sides of the leg



B Type

사이즈 : W2800 x D1200 x H730(조명 제외)
 구성 : W2000상판 + 보강바(2ea)
 + W400 확장상판(2ea)
 조립 방법 : 다리발 일면 내측 결합, 일면 외측 결합

Size : W2800 x D1200 x H730(Light Excluded)
 Composition : W2000 Top Panel + Assist Beam(2ea)
 + W400 Extended Top Panel(2ea)
 Assembling method : Joining on both inner sides of the leg +
 Joining on one inner side of the leg



C Type

사이즈 : W4000 x D1200 x H730(조명 제외)
 구성 : W2000상판(2EA) + 보강바(2EA)
 조립 방법 : 다리발 일면 내측 결합, 일면 외측 결합

Size : W4000 x D1200 x H730(Light Excluded)
 Composition : W2000 Top Panel(2ea) + Assist Beam(2ea)
 Assembling method : Joining on one inner side of the leg
 + Joining on one outside side

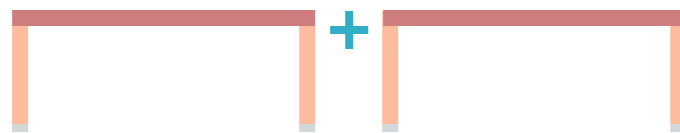

D Type

사이즈 : W4800 x D1200 x H730(조명 제외)
 구성 : W2000상판(2EA) + 보강바(2 SET)
 + W400확장상판(2EA) +연장 보강바(2 SET)
 조립 방법 : 다리발 양쪽 외측 결합

Size : W4800 x D1200 x H730(Light Excluded)
 Composition : W2000 Top Panel(2ea) + Assist Beam(2ea) + W400 Extended
 Top Panel(2ea) + Extended Assist Beam(2ea)
 Assembling method : Joining on both outside sides of the leg

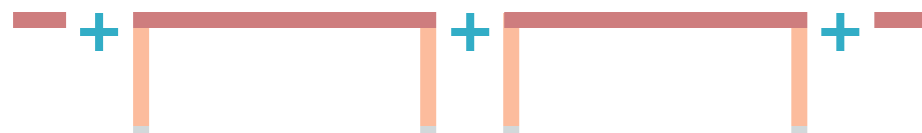

Hub-T

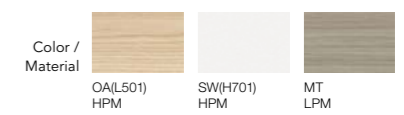

W2000 팀테이블
 W2000 Co-Working Table
 H010420 ~ 22 2000 · 1200 · 730

Color: OA / SW / MT



W2000 팀테이블(덕트형)
 W2000 Co-Working Table
 (Duct Included)
 H010423 ~ 25 2000 · 1200 · 730

Color: OA / SW / MT



W2800 팀테이블
 W2800 Co-Working Table
 H010730 ~ 32 2800 · 1200 · 730

Color: OA / SW / MT



W2800 팀테이블(덕트형)
 W2800 Co-Working Table
 (Duct Included)
 H010733 ~ 35 2800 · 1200 · 730

Color: OA / SW / MT



W4000 팀테이블
 W4000 Co-Working Table
 H010736 ~ 38 4000 · 1200 · 730

Color: OA / SW / MT



W4000 팀테이블(덕트형)
 W4000 Co-Working Table
 (Duct Included)
 H010739 ~ 41 4000 · 1200 · 730

Color: OA / SW / MT



W4800 팀테이블
 W4800 Co-Working Table
 H010742 ~ 44 4800 · 1200 · 730

Color: OA / SW / MT



W4800 팀테이블(덕트형)
 W4800 Co-Working Table
 (Duct Included)
 H010745 ~ 47 4800 · 1200 · 730

Color: OA / SW / MT



400 확장상판 400
 Extended Top Panel
 H010426 ~ 28 400 · 1200 · 730

Color: OA / SW / MT



T 조명 Table Light
 H009743(EK)
 H009744(SW)

Color: BK / SW



사이드스크린 Side Screen
 H009745

Color: GY

CT 2000 Group

The conference table with modern, sophisticated design and structural stability

모던하고 세련된 디자인과 구조적 안정성을 모두 갖춘 회의테이블

회의의 규모와 목적에 따른 다양한 회의실 연출이 가능하도록 설계된 시스템.

회의테이블은 소재의 조화로우름을 통해 개성있고 우아한 공간 분위기를 창출해드립니다.

The tables for various conferences are the essence for original and refined space.



회의테이블 CT2236B



- 1 알루미늄 양문형 덕트 콘센트는 랜포트, USB 2PORT, 4구 콘센트 사용이 가능합니다. (옵션 항목 : 블랙, 화이트)
 - 2 연결용 상판과 테이블 연결시 사용되는 견고한 알루미늄 다이캐스팅 브라켓.
- 1 This aluminum double-door duct socket-outlets are available with LAN port, USB 2 port, and 4 sockets-outlet (option : black, white)
 - 2 Solid aluminum die-casting bracket used for connecting the top part and table.

CT 2000 Group

친환경 소재를 사용하고, 재활용 및 폐기를 위해 재료의 분리가 용이하도록 구조 설계되었습니다.
Environment-friendly materials are used and their separation is easy for recycling and disposal.

Color / Material	Color / Material
N(L641) HPM	SW(L701) HPM

단독 일반형 Single General Type

CT2018	1800 · 900 · 730
CT2021	2100 · 1050 · 730
CT2024	2400 · 1050 · 730



Color. SW / N

연결 일반형 Connecting General Type

CT2036B	3600 · 1200 · 730
CT2048B	4800 · 1200 · 730



Color. SW / N

단독 덕트형 Single Duct Type

CT2218	1800 · 900 · 730
CT2221	2100 · 1050 · 730
CT2224	2400 · 1050 · 730



Color. SW / N

연결 덕트형 Connecting Duct Type

CT2236B	3600 · 1200 · 730
CT2248B	4800 · 1200 · 730



Color. SW / N

원형 Round Type

CT2010R	ø1000 · 730
---------	-------------



Color. SW / N

연결용 상판 Connecting Top Part

CT2008B	800 · 1200 · T30
---------	------------------



Color. SW / N

SWING

Folding table features sensitive design that enhances user concentration and offers a convenient mechanism

집중도를 높이는 감각적인 디자인과 편리한 메커니즘

상판을 간단하게 접을 수 있는 편리한 메커니즘은 자유로운 이동과 적층식 구조의 보관으로 사용공간을 더욱 자유롭게 연출합니다.

Folding Table offers a convenient mechanism enabling easy folding. You may utilize the space more flexibly with such features as it can be freely moved and storage in a stacked state.



테이블 FT5615S 강연대 EPU3050T



1. FT5600

2. FT5600

3. FT5700

4. FT5800

SWING

Color / Material	G(H542) HPM	B(H541) HPM	SW(H701) HPM
------------------	-------------	-------------	--------------



가림판 부착형 With the Modesty Panel	
고급형(우레탄 엣지) High Grade(Urethane Edge)	
FT5614US	1400 · 500 · 745
FT5615US	1500 · 500 · 745
FT5618US	1800 · 500 · 745
일반형(ABS 엣지) Normal(ABS Edge)	
FT5614S	1400 · 550 · 745
FT5615S	1500 · 550 · 745
FT5618S	1800 · 550 · 745

Color. SW



전면 노출형 Without the Modesty Panel	
고급형(우레탄 엣지) High Grade(Urethane Edge)	
FT5614U	1400 · 500 · 745
FT5615U	1500 · 500 · 745
FT5618U	1800 · 500 · 745
일반형(ABS 엣지) Normal(ABS Edge)	
FT5614	1400 · 500 · 745
FT5615	1500 · 500 · 745
FT5618	1800 · 500 · 745

Color. SW



가림판 부착형 With the Modesty Panel	
고급형(우레탄 엣지) High Grade(Urethane Edge)	
FT5514S	1400 · 500 · 720
FT5515S	1500 · 500 · 720
FT5518S	1800 · 500 · 720
일반형(일반 엣지) Normal(General Edge)	
FT5415S	1500 · 550 · 720
FT5418S	1800 · 550 · 720

Color. G / B



전면 노출형 Without the Modesty Panel	
고급형(우레탄 엣지) High Grade(Urethane Edge)	
FT5514	1400 · 500 · 720
FT5515	1500 · 500 · 720
FT5518	1800 · 500 · 720
일반형(일반 엣지) Normal(General Edge)	
FT5415	1500 · 550 · 720
FT5418	1800 · 550 · 720

Color. G / B



1인풀딩테이블 For 1 Person	
FT5709US	900 · 550 · 731
2인풀딩테이블 For 2 Person	
FT5715US	1500 · 550 · 731

Color. SW



가림판 부착형 With the Modesty Panel	
고급형(우레탄 엣지, 선반 無) High Grade (Urethane Edge, Shelf Deleted Type)	
FT5814S	1400 · 500 · 720
FT5815S	1500 · 500 · 720
FT5818S	1800 · 500 · 720



고급형(우레탄 엣지, 선반 無) High Grade (Urethane Edge, Shelf Deleted Type)	
FT5814	1500 · 550 · 720
FT5815	1800 · 550 · 720
FT5818	1800 · 550 · 720

Color. G / B



강연대 Lecture Table EPU107	
	700 · 500 · 975

Color. G / B

CLECS

Effective information exchange and efficient space application

효과적인 정보교류와 효율적인 공간활용

다양한 목적과 규모의 강의환경에 대응할 수 있는 제품구성과 네오스만의 특별한 기능과 디자인으로 최적의 강의 환경을 구현합니다.

It can realize the optimal lecture environment with the product composition dealing with multiple purposes and scale of lecture environment and Neoce's special functions and design.



테이블 ED300W 의자 EH300

CLECS

Color / Material	B(H541) HPM	G(H542) HPM	SW(L701) SW(H701)	BU(CF341) FABRIC	GY(CF344) FABRIC	PF48 (DARK GRAY) FABRIC	PF49 (LIGHT GRAY) FABRIC	PF50 (DARK BLUE) FABRIC
	테이블 & 웨건 Table & Wagon			의자 Chair		스크린 Screen		



폴딩 테이블 Folding Table
ED300 684 · 490 · 720

Color. B / G



폴딩 테이블 Folding Table
ED300W (ABS엣지 ABS Edge)
ED300U (우레탄엣지 Urethane Edge)
684 · 490 · 745

Color. SW



폴딩 체어(캐스터형)
Folding Chair(Caster Type)
EH300 593 · 537 · 771
EH300W 593 · 537 · 771

Color. BU / GY



폴딩 체어(캐스터형)
Folding Chair(Caster Type)
EH310 544 · 537 · 771
EH310W 544 · 537 · 771

Color. BU / GY



강연대 Lecture Table
EPU3050T 540 · 567 · 1149

Color. G



웨건 Lecture Wagon
EPU3050W 540 · 567 · 1149

Color. G



스크린 Screen
ESB3090S 942 · 674 · 1805
양면 패브릭 Double Fabric

Color. PF48 / PF49 / PF50



스크린 Screen
ESB3090B 942 · 674 · 1805
일면 화이트보드, 일면 블랙보드
Single Whiteboard, Single Blackboard

Color. WH+BK

- 1 책상 상판 하부의 레버를 당겨 간편하게 접을 수 있는 폴딩 메커니즘.(적층식 보관)
- 2 의자 폴딩 메커니즘.

- 1 The desk, with a folding mechanism, is easily folded by pulling a lever under the board of the desk. (Stacked storage)
- 2 The chair is equipped with a folding mechanism.



PC Table

The PC table for optimal education space

최적의 교육공간을 위한 PC테이블, EMD 100G

책상 상판의 모니터홀더와 옵션으로 선택 가능한 CPU홀더를 통해 컴퓨터의 보안과 관리를 편리하게 할 수 있습니다.

You can make the security and management of computers convenient by monitor holders on top of the desk and optional CPU holders.



테이블 EMD1018

- 1 보안과 관리가 용이한 모니터 홀더.
- 2 책상에 부착가능한 CPU홀더.(옵션)

- 1 Monitor holder for security and easy management.
- 2 CPU holder (optional) which can be attached to desk.



PC Table

Color / Material	PE(L402) LPM	SW(L701) LPM



PC테이블(LCD 모니터용)
PC Table(for LCD Monitors)
1인용 for 1 Student
EMD1009 900 · 600 · 765

Color. SW / PE



PC테이블(LCD 모니터용)
PC Table(for LCD Monitors)
2인용 for 2 Student
EMD1018 1800 · 600 · 765

Color. SW / PE



CPU 홀더 CPU Holder

1인용 for 1 Person
EPC1010 173 · 420 · 522
2인용 for 2 Person
EPC1020 309 · 420 · 522

EXECUTIVE

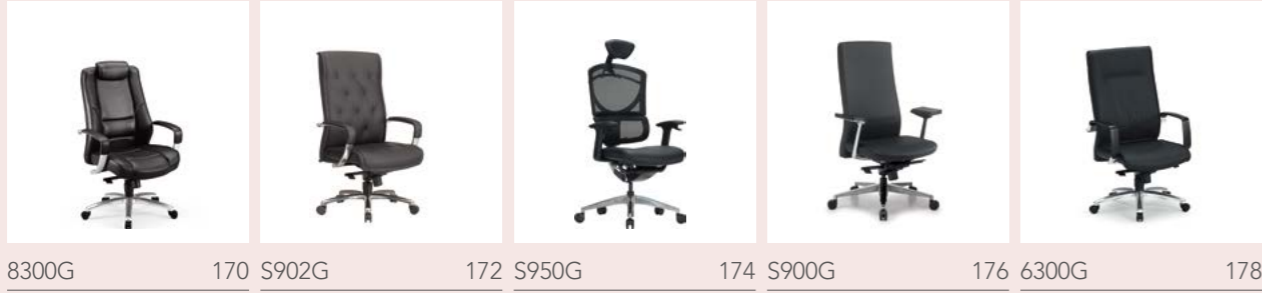

TASK

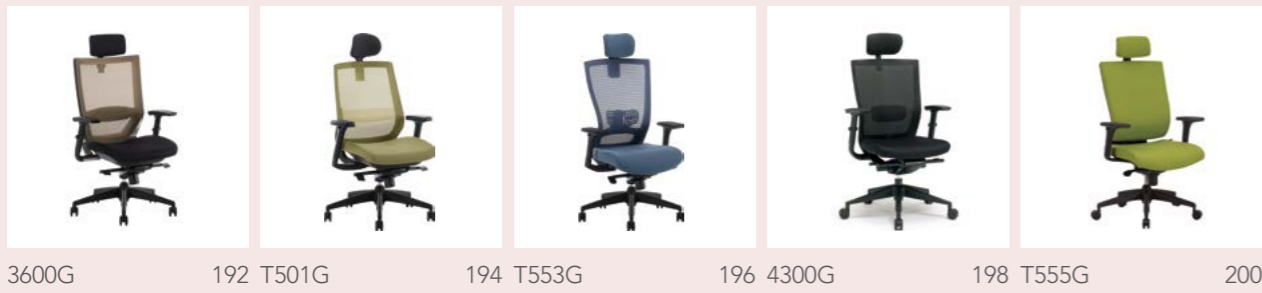

MULTI-USE



Office SEATING

MULTI-USE



LOBBY



STOOL



COMFORT AND PERFORMANCE

머리받이 조절 기능 및 기타 Headrest Adjustment & Etc.

머리받이 높이조절 Headrest Height Adjustment
머리받이에 높이 조절을 적용하여 사용자가 원하는 위치 조절
A user can adjust the position with height-adjustable headrest.

머리받이 회전기능 Headrest Adjustment : Rotation
머리받이에 회전 기능을 적용하여 사용자의 미세한 자세 교정이 가능
Delicate adjustment of position with the headrest rotation.

머리받이 프리텐션 Headrest Free Tention
머리받이가 앞으로 움직여 사용자에게 편안한 텐션을 제공
Headrest free-tension- tilt control with adjustable tension for comfort.

옷걸이 높이조절 Stylish Hanger Height Adjustment
사용자가 원하는 걸이의 위치를 조절
A user can adjust the position with the movable stylish hanger.

**이중바퀴 구조의 우레탄 캐스터
Dual Wheel Urethane Caster**
조용하고 부드럽게 이동이 가능한 기능성 볼캐스터
It doesn't make noise and easy to move.

**시브레이크 캐스터
Seat Brake Caster**
의자에 앉을 경우 바퀴가 쉽게 굴러가지 않는 기능성 볼캐스터
A functional ball type of castor that prevents the wheels from rolling during use.

등받이 조절 기능 Backrest Adjustment

허리받침 높이조절 Lumbar Support Height Adjustment
등판 요추 부위의 하드웨어를 적용하여 사용자가 원하는 높이 조절
Users can adjust the height with the backrest and lumbar support hardware.

등판 리클라인 기능 Back Recline Angle Adjustment
허리 부분의 등판에 가해지는 하중의 강도에 따라 일정한 텐션으로 꺾혀지는 기능
Synchro-Tilt and tilt lock mechanism

라이트 스파인 컨트롤기능 Right Spine Control System
양쪽의 등판 받침대가 허리에 밀착 되도록 조절되어 허리받침 강도조절 및 온/오프 조절
Adjustable built-in lumbar support with side support buttresses.

등판 프리텐션 Backrest Free Tention
등판의 양쪽에 텐션을 조절하는 레버가 장착되어 좌/우로 등판의 움직임은 온/오프 조절
Tension adjusting levers on both sides of the back.

포워드 기능 Forward Tilting
사용자의 업무 스타일에 따라 등-좌판이 각도를 조절하여 업무에 집중할 수 있는 자세를 유지
Forward tilt of the back seat and tilt adjustment of the seat pan.

**등판 플렉서블 서포트기능
Backrest Flexible Support Mechanisms**
사용자의 다양한 체형과 업무 스타일에 따라 적합한 텐션을 유지시켜주는 기능
Adjustable seat tilt tension to fit users of varying sizes and seating preferences.

**등받이 높이조절
Backrest Height Adjustment**
등받이에 높이 조절을 적용하여 사용자가 원하는 위치 조절
Backrest height is adjustable simply by using the height adjustment feature.

**다이나믹 피팅 백 시스템
Dynamic Fitting Back System**
등받이 하단을 올려 사용자의 허리에 직접 맞출 수 있는 기능
Ability to directly adjust to the user's back by raising the bottom of the backrest.

틸트 조절 기능 Tilt Adjustment

다중 틸트 고정장치 Multi-Locking
기울기 고정각이 단계별로 조절되어 원하는 각도에서 등좌판의 기울기를 고정하여 업무와 휴식을 위한 최적의 상태로 온/오프
Specific angles of tilt are provided enabling user to choose angle according to preference.

틸트 온/오프 Tilt On/Off
의자의 처음 각도에서 틸트 기능을 온/오프
The tilt function can be activated at the initial angle of the chair by switching on and off.

틸팅 범위조절(멀티 리미티드) Multi-limited Tilt
틸팅 각의 범위를 단계별로 조절할 수 있는 메커니즘
The mechanism which users can adjust degrees of a tilt.

싱크로나이즈드 틸트 Synchronized Tilt
등판과 좌판이 다른 각도로 기울어져 등과 허벅지 부분의 압박을 최소화한 메커니즘
A mechanism designed to minimize pressure on users' backs and thighs through the tilting of back rests and seats in different angles.

백 틸트 Back Tilt
고정된 좌판에 일정한 각도로 틸팅되는 등판을 적용한 기본형 메커니즘
Standard mechanism allowing a fixed amount of tilt.

니 틸트 Knee Tilt
등판과 좌판이 같은 각도로 틸팅되는 기본형 메커니즘
Basic mechanism in which the backboard and the seat are tilted at the same angle.

틸트 강도조절 Tilting Strength Adjustment
틸트 메커니즘에 부착된 원형 손잡이를 회전시켜 사용자가 원하는 등좌판 틸팅 강도를 Soft 또는 Hard하게 조절
Using the handle attached to the tilt mechanism, the user can adjust the strength of the tilting (Soft or Hard) according to his/her preference.

팔걸이 및 좌판 조절 기능 Armrest & Seat Adjustment

팔걸이 높이조절 Armrest Height Adjustment
팔걸이의 상하 이동이 가능한 하드웨어를 적용하여 업무 환경에 따른 원하는 팔걸이 높이를 조절
Mechanism enabling user to vertically adjust the position of armrest according to preference or work environment.

팔걸이 각도조절 Arm Pads Angle Adjustment
팔걸이 패드의 각도 조절이 가능하여 업무 환경에 따른 팔꿈치 긴장감 완화
With angle-adjustable pad on armrests, it helps release tension on the elbow.

팔걸이 전후조절 Arm Pads Back and Forth Adjustment
팔걸이 전후 조절이 가능하여 업무 환경에 따라 원하는 팔걸이 위치 조절
The arm rest can be adjusted to and fro for your most convenient working condition.

팔걸이 폭조절 Armrest Width Adjustment
다양한 체형의 사용자에게 최적의 업무 환경을 제공하기 위하여 팔걸이의 폭을 유기적으로 조절
The armrest width adjustment mechanism is designed to provide users of varying body sizes with the optimal working environment.

가스식 높낮이조절 Gas Spray Seat Height Adjustment
고압의 가스 실린더를 사용하여 사용자가 원하는 좌판의 높낮이를 신속하게 조절
Using a high-pressured gas cylinder, the height of the chair can be immediately modified by the user.

좌판 깊이조절 Seat Depth Adjustment
다양한 체형의 사용자에게 최적의 착석감을 제공하기 위하여 좌판의 깊이를 유기적으로 조절
Depending on the physique of each individual the seat of the chair can be adjusted to each individual preference.

좌판앞 기울기조절 Seat Pan Tilt Adjustment
좌판의 기울기를 앞으로 고정하여 업무의 집중도 및 착좌감을 위한 상태로 온/오프
Neoce chairs offer tilt adjustment of the seat pan for users to adjust the depth and focus on their work in comfort.

중심봉 반전 메커니즘 Auto-Return Mechanism
반전 중심봉에 의해 좌판의 회전 위치가 복원되는 기능
The rotation position is recovered by the auto-reverse gas spindle.

팔걸이 스윙블 Armrest Swivel
사용상 팔걸이가 불필요한 경우 상단으로 올려둘 수 있는 기능
A feature that enables users to lift the armrest when it is not in use.

발받침 높이조절 Chair Base Height Adjustment
사용자의 키에 맞게 발받침 높낮이 조절 기능
A feature enabling users to adjust the chair's height according to their own height.

8300G

최고의 명예와 품격의 비즈니스 공간, 그 특별한 공간을 위한 최고급 중역의자 - 8300G. 트렌디한 최고급 천연 가죽과 틸팅시에 부드럽게 슬라이딩되는 팔걸이의 세심함이 더욱 돋보입니다.

The executive chairs for the businessmen for the honored position and the particularly advanced business space. 8300G features the crowning trendy natural leather and the delicate armrest softly sliding in tilting at the back.



한국산업디자인상
Korea Industrial
Design Awards



굿디자인
GOOD
DESIGN

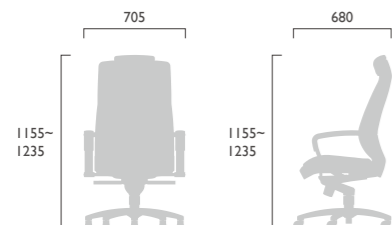

L(CG831)
GENUINE LEATHER

- 1 인체의 움직임에 맞추어 등판과 좌판이 각기 다른 각도로 틸팅되는 싱크로나이즈드 틸팅기능과 등판의 기울기가 5단계로 조절되는 멀티 락킹 틸팅기능을 갖추었습니다.
- 2 사용자의 미세한 자세 교정이 가능하도록 머리받이 높이를 조절할 수 있습니다.
- 3 의자에 하중을 가하지 않은 상태에서 손잡이를 위로 당기면 좌판이 올라가고, 하중을 가한 상태에서 손잡이를 위로 당기면 좌판이 내려갑니다.

- 1 The backrest and seat tilt in a synchronized way according to a user's movements. And it has a multi-locking tilt function to fix the backrest at the desired angle through 5 reclining stages.
- 2 Minor adjustment of position with the headrest height adjustment.
- 3 While pulling without weight, the seat will automatically rise. When weight is put on top of the chair while pulling, then the chair will descend.



Seating
Executive
8300G

OH 8350
W705 D680 H1155~1235



OH 8330
W705 D680 H1110~1190

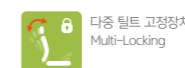
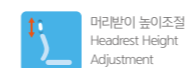

S902G

시대를 이끄는 분들의 품격을 담은 최고급 중역의자 S902G.

당신이 걸어온 길에 대한 차별화된 예우를 선사합니다.

The highest quality executive chair designed for trailblazers.

S902G is a special treat that you deserve for your courage in your lifelong career.

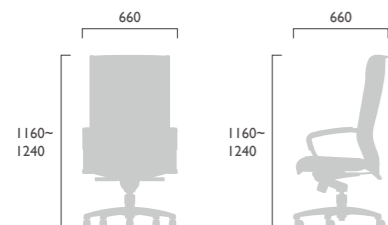

Color / Material



L(CG631) GENUINE LEATHER A(CA631) ARTIFICIAL LEATHER

- 1 오토만과 함께 구성되어 편의성과 고급스러움을 더했습니다.
- 2 인체의 움직임에 맞추어 등판과 좌판이 각기 다른 각도로 틸팅되는 싱크로나이즈드 틸팅기능과 등판의 기울기가 5단계로 조절되는 멀티 락킹 틸팅기능을 갖추었습니다.
- 3 고급 가죽에서 느낄 수 있는 높은 품격과 함께 등판의 패턴으로 세련된 공간을 연출합니다.
- 4 세련된 전체 라인과 이어지는 가죽마감 팔걸이로 편안함과 안락함을 부여합니다.

- 1 Combined with an ottoman, it guarantees convenience as well as elegance.
- 2 The backrest and seat tilt in a synchronized way according to a user's movements. And it has a multi-locking tilt function to fix the backrest at the desired angle through 5 reclining stages.
- 3 The high-quality leather attests to your integrity. The pattern on the backrest perfectly matches the exquisiteness of your space.
- 4 The linear elegance of the design is enhanced by the robustness of the leather-trimmed armrest which guarantees you both convenience and comfort.



SOH 90240
W660 D660 H1160-1240



SOH 90230
W660 D620 H1030-1110



SOH 902LSL
W500 D385 H400

SOH 902LSA
W500 D385 H400

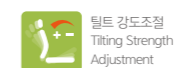

S950G

사용자의 움직임에 맞춘 다양한 기능들로 최상의 안락감을 제공하는 S950G

사용자 편의성 중심의 기능으로 업무 집중력을 향상시키며
스마트한 느낌을 주는 중역용 의자입니다.

Ergonomic chair fitting user's movement with various functions.
Smart executive chair focus on user's convenience improves concentration.

Color / Material
등판 BACK
좌판 SEAT
CM9501
MESH
BLACK(CA9501)
ARTIFICIAL LEATHER

- 1 와이어를 적용한 '등판각도 고정/해제'와 '좌판 높낮이 조절' 기능으로 자세에 변화 없이 팔걸이 아래 레버로 쉽게 조절할 수 있습니다.
- 2 등판과 등판을 지지하는 포스트 사이에 탄성 소재 부품을 적용, 사용자의 무의식적인 움직임에도 등판이 따라 움직여 편안합니다.
- 3 표준화되어 있는 의자의 등판 높이로 인해 불편함을 느꼈던 사용자들을 위해 등판의 높이만 체형에 맞춰 조절할 수 있습니다.
- 4 좌판 좌측면에 위치한 레버를 누른 상태에서 앞뒤로 밀면 좌판이 슬라이딩되어 손쉽게 좌판의 깊이를 조절할 수 있습니다.

- 1 'Back angle holding function' and 'seating height adjust function' is controlled easily by lever below armrest.
- 2 Rubber material is applied between back and back post that provides soft movement.
- 3 Back height adjustable function provides more comfortable seat compare to standardized back height.
- 4 Easy seat length control with lever on left side.



CSOH 95052A
W665 D650-700 H1160-1230

CSOH 95032A
W665 D590-640 H1020-1090

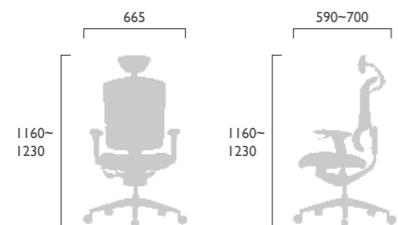

- | | | | | |
|---|---|--|--|---|
| 머리받이 높이조절
Headrest Height Adjustment | 머리받이 회전기능
Headrest Adjustment : Rotation | 이중바퀴 구조의 우레탄 캐스터
Dual Wheel Urethane Caster | 등판 프리텐션
Backrest Free Tention | 등판 리클라인 기능
Back Recline Angle Adjustment |
| 등받이 높이조절
Backrest Height Adjustment | 싱크로나이즈드 틸트
Synchronized Tilt | 다중 틸트 고정장치
Multi-Locking | 틸트 강도조절
Tilting Strength Adjustment | 팔걸이 높이조절
Armrest Height Adjustment |
| 팔걸이 각도조절
Arm Pads Angle Adjustment | 가스식 높낮이조절
Gas Spray Seat Height Adjustment | 좌판 깊이조절
Seat Depth Adjustment | | |

S900G

고급 가족에서 우러나오는 품격, 인체공학적 설계에 의한 뛰어난 안락감, 불필요한 장식을 배제한 간결한 디자인으로 탄생된 네오스 고급 사무용 의자 S900G.

The utmost in class and luxury, with an ergonomic design that guarantees outstanding comfort, the luxury office chair S900G shows the true beauty of absolute simplicity.



한국산업디자인상
Korea Industrial
Design Awards

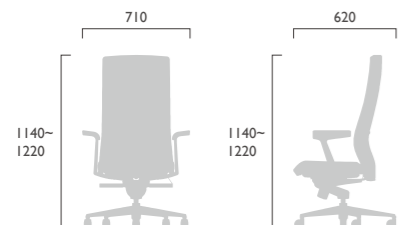

Color / Material

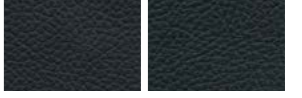

L(GG631) GENUINE LEATHER
A(CA631) ARTIFICIAL LEATHER

- 1 인체의 움직임에 맞추어 등판과 좌판이 각기 다른 각도로 틸팅되는 싱크로나이즈드 틸팅기능과 등판의 기울기가 5단계로 조절되는 멀티 락킹 틸팅기능을 갖추었습니다.
- 2 고급 가족에서 느낄 수 있는 높은 품격과 함께 등판 뒷부분을 메탈 바를 부착하여 고급스럽습니다.
- 3 팔이 닿는 부분에 넓은면적의 발포우레탄을 사용하여 최적의 안락감을 제공합니다.

- 1 The backrest and seat tilt in a synchronized way according to a user's movements. And it has a multi-locking tilt function to fix the backrest at the desired angle through 5 reclining stages.
- 2 The high quality leather and the metal bar attached on the back add to its class.
- 3 The sizeable armrest covered with polyurethane foam offers the user the highest level of comfort.



Seating
Executive
S900G

SOH 90040L
W710 D620 H1140-1220

SOH 90040A
W710 D620 H1140-1220



SOH 90030L
W710 D600 H980-1060

SOH 90030A
W710 D600 H980-1060



6300G

인체곡선을 따라 흐르는 부드러운 곡선과
간결한 직선이 조화된 중역의자 - 6300G.
우수한 안락감과 실용성을 겸비하고 서로 다른
질감의 조화로움이 품격을 한층 높여드립니다.
A executive chair which shows a concise
straight line and a beautiful curve - 6300G.
The outstanding comfort and efficiency
ennobles you with harmony of the different
feel of a material.



BIFMA
(Business & Institutional
Furniture Manufacturer's
Association)

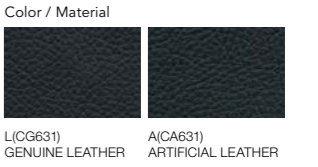
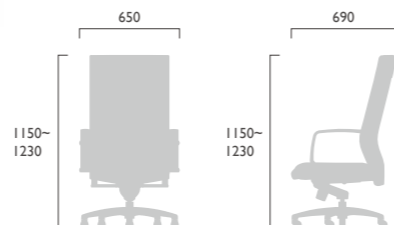

- 1 인체의 움직임에 맞추어 등판과 좌판이 각기 다른 각도로 틸팅되는 싱크로나이즈드 틸트기능과 등판의 기울기가 5단계로 조절되는 멀티락킹 틸트기능을 갖추었습니다.
 - 2 체형에 따라 원하는대로 높낮이를 쉽게 조절할 수 있는 원터치 높낮이 조절 레버.
- 1 The backrest and seat tilt in a synchronized way according to a user's movements. And it has a multi-locking tilt function to fix the backrest at the desired angle through 5 reclining stages.
 - 2 A one touch lever in which you can easily adjust the height according to your body type.



Seating Executive 6300G



OH 6340L
W650 W690 H1150-1230

OH 6340A
W650 W690 H1150-1230



OH 6330L
W650 D640 H980-1060

OH 6330A
W650 D640 H980-1060

- 싱크로나이즈드 틸트 Synchronized Tilt
- 다중 틸트 고정장치 Multi-Locking
- 틸트 강도조절 Tilting Strength Adjustment
- 가스식 높낮이조절 Gas Spray Seat Height Adjustment

T558G

사각 형태의 디자인으로 인체공학적 설계와 다양한 사용자 중심의 기능을 적용하였습니다. 다양한 사무환경에도 어울리는 디자인과 사용자 맞춤 조절기능은 편안한 착석감을 느낄 수 있게 해줍니다.

Ergonomic square shape design focus on user's convenience.
Design for various office conditions provides comfortable seat.



헤드레스트 Headrest

- 1 사각형 형태의 넓은 헤드레스트는 머리를 편안하게 받쳐주어 업무 피로도를 낮출 수 있습니다. 부드러운 쿠션은 경추부를 탄력 있게 지지해줍니다.
- 2 코트 행거는 겨울철 사무실에서 개인 코트 보관을 용이하게 도와줍니다.
- 3 헤드레스트는 위/아래로 높낮이 조절이 가능합니다.

- 1 The wide rectangular headrest supports the head in a comfortable position, reducing a sense of fatigue from work. The soft cushion flexibly supports the cervical vertebra.
- 2 Coat hanger helps people to easily store their coats in office in the winter time.
- 3 The headrest can be adjusted up / down.



Seating Task

팔걸이 Armrest

- 1 높낮이 조절
 - 2 전/후 슬라이딩
 - 3 좌/우 회전
- 1 Height adjustment
 - 2 Sliding forward / backwards
 - 3 Rotate Left / Right



T558G

좌판 Seat

- 1 좌판을 밀고 당겨 깊이를 조절할 수 있습니다. 사용자의 체형에 맞춰 사용하면 장시간 착석시에도 피로도를 최소화할 수 있습니다.
 - 2 좌판에 오염이 있을 경우 교체가 가능하도록 제작되었습니다. 사용자가 손쉽게 좌판 패브릭과 스펀지를 교환할 수 있습니다.
- 1 Depth can be adjusted by pushing and pulling the seat. If the you make it fit to your body shape, you can minimize a sense of fatigue even when you are in the seat for a long time.
 - 2 It is designed to be replaceable if the seat is dirty. The user can easily exchange the seat fabric and sponge.



요추지지대 Lumbar supporter

요추지지대는 높이 조절이 가능하여 사용자의 체형에 맞춰 사용할 수 있습니다.

The height of the lumbar support can be adjusted to fit the user's body shape.



틸트 Tilt

ITALY DONATI 사 메커니즘을 적용하여 보다 우수한 착석감과 내구성을 자랑합니다.

ITALY DONAT CO, Ltd., Mechanism is applied.



머리받이 높이조절 Headrest Height Adjustment	이중바퀴 구조의 우레탄 캐스터 Dual Wheel Urethane Caster	허리받침 높이조절 Lumbar Support Height Adjustment	싱크로나이즈드 틸트 Synchronized Tilt	다중 틸트 고정장치 Multi-Locking	틸트 강도조절 Tilting Strength Adjustment
좌판 깊이조절 Seat Depth Adjustment	가스식 높낮이조절 Gas Spray Seat Height Adjustment	팔걸이 높이조절 Armrest Height Adjustment	팔걸이 전-후조절 Arm Pads Back and Forth Adjustment	팔걸이 각도조절 Arm Pads Angle Adjustment	

화이트 체어 WHITE CHAIR

Color / Material	
등판 BACK	GY(CM5582) MESH
좌판 SEAT	DG(CF5582) FABRIC
등판 BACK	GY(CM5582) MESH
좌판 SEAT	LB(CF5584) FABRIC
등판 BACK	GY(CM5582) MESH
좌판 SEAT	GN(CF5585) FABRIC
등판 BACK	GY(CM5582) MESH
좌판 SEAT	GY(CA5582) ARTIFICIAL LEATHER

미들백형
MID-BACK TYPE



TOH55832LWDG(LB/GN)
W635 D580 H980-1120

TOH55832LWAGY
W635 D580 H990-1080

헤드레스트형
HEADREST TYPE



TOH55852LWDG(LB/GN)*
W635 D580 H1155-1255

TOH55852LWAGY*
W635 D580 H1165-1255

블랙 체어 BLACK CHAIR

Color / Material	
등판 BACK	BK(CM5581) MESH
좌판 SEAT	BK(CF5581) FABRIC
등판 BACK	BK(CM5581) MESH
좌판 SEAT	BU(CF5583) FABRIC
등판 BACK	BK(CM5581) MESH
좌판 SEAT	GN(CF5585) FABRIC
등판 BACK	BK(CM5581) MESH
좌판 SEAT	BK(CA5581) ARTIFICIAL LEATHER

미들백형
MID-BACK TYPE



TOH55832LBDG(BU/GN)
W635 D580 H980-1120

TOH55832LBABK
W635 D580 H990-1080

헤드레스트형
HEADREST TYPE



TOH55852LBDG(BU/GN)*
W635 D580 H1155-1255

TOH55852LBABK
W635 D580 H1165-1255

코트행거형
COAT HANGER TYPE



TOH55862LWDG(LB/GN)*
W635 D665 H1040-1180

TOH55862LWAGY(LB/GN)*
W635 D580 H1050-1140

코트행거+헤드레스트형
COAT HANGER+HEADREST TYPE



TOH55872LWDG(LB/GN)*
W635 D665 H1155-1255

TOH55872LWAGY(LB/GN)*
W635 D665 H1165-1255

코트행거형
COAT HANGER TYPE



TOH55862LBDG(BU/GN)*
W635 D665 H1040-1180

TOH55862LBABK
W635 D580 H1050-1140

코트행거+헤드레스트형
COAT HANGER+HEADREST TYPE



TOH55872LBDG(BU/GN)*
W635 D665 H1155-1255

TOH55872LBABK
W635 D665 H1165-1255

TASK

T500G

진정한 기능성 사무용 의자 T500G는 의자 사용시 사용자의 인체 움직임과 동선을 면밀히 연구하여, 인간공학에 의해 설계된 사무용 의자입니다. 또한 편안한 구조와 함께 다양하고 뛰어난 기능을 갖추고 있는 미래형 사무용 의자입니다.

Designing an ergonomic office chair requires in depth research on body movement while seated as well as a user's traffic line in their office. T500G provides comfort and superb functionality to meet with every need in the office of the future.

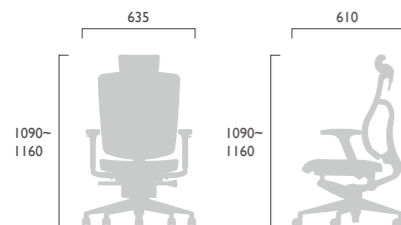

	Color / Material		
등판 BACK			
좌판 SEAT			
	GY(CM5001) MESH	BU(CM5002) MESH	GN(CM5003) MESH
	BLACK FABRIC	BLACK FABRIC	BLACK FABRIC

- 1 의자의 등판에 가해지는 하중의 강도에 따라 가장 적합한 텐션으로 자연스럽게 찾혀지는 리클라인 메커니즘을 적용하였습니다.
- 1 The original design supports a user's back with adequate tension depending on the load applied to the seat's backrest.
- 2 인체의 움직임에 맞추어 등판과 좌판이 각기 다른 각도로 탈딩되는 싱크로나이즈드 틸트 기능을 적용하였습니다.
- 2 The backrest and seat tilt in a synchronized way according to a user's movements.
- 3 사용자의 체형과 업무스타일에 따라 좌판 깊이를 6단계(50mm)로 조절하여 편리합니다.
- 3 Users can change the depth of the chair in 6 different stages (50mm intervals by each stage) depending on their body shape and professional needs.
- 4 등판의 기울기가 조절되어 원하는 각도로 고정사용할 수 있는 멀티 락킹 틸트 기능을 갖추었습니다.
- 4 The angle of the seat can be adjusted to 3 different angles.
- 5 등판의 기울기가 조절되어 원하는 각도로 고정사용할 수 있는 멀티 락킹 틸트 기능을 갖추었습니다.
- 5 It has a multi-locking tilt function to fix the backrest at the desired angle.
- 6 팔걸이 전·후 각도 조절이 가능하며 업무 환경에 따라 팔걸이 위치를 조절할 수 있습니다.
- 6 The armrests can be moved in two different positions according to a user's needs.



Seating Task T500G

헤드레스트형 HEADREST TYPE

TOH 50052S
W635 D610 H1090-1160



미들백형 MID-BACK TYPE

TOH 50032S
W635 D610 H990-1060



- | | | | |
|--|--|--|--|
| | | | |
| | | | |
| | | | |
| | | | |

T559G

인체공학적 설계를 적용한 DFB(Dynamic Fitting Back) SYSTEM을 적용하여 척추 형상에 맞도록 등판을 조절하여 사용할 수 있습니다. 사용자별 맞춤형 조절은 올바른 자세를 유도하고 척추의 하중을 분산하여 장시간 사용에도 편안함을 느낄 수 있습니다.

By applying DFB (Dynamic Fitting Back) SYSTEM to which an ergonomic design is applied, you can adjust the back plate to fit the spine shape. Customized adjustments for each user lead the user to sit in the correct posture and spread the load on the spine, making the user feel comfortable for extended use.

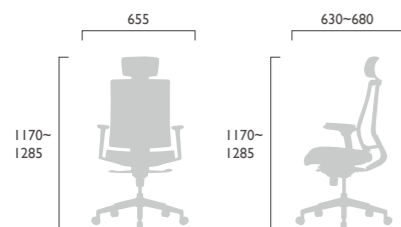

	Color / Material				
등판 BACK					
좌판 SEAT					
	GY(CM5592) MESH	BE(CM5591) MESH	BE(CM5591) MESH	BE(CM5591) MESH	BE(CM5591) MESH
	GY(CM5592) MESH	GY(CF5591) FABRIC	BE(CF5592) FABRIC	LB(CF5593) FABRIC	RE(CG5594) FABRIC

- 1 기능성 조절 등판인 DFB System (Dynamic Fitting Back System)를 적용하여 사용자의 허리에 직접 맞출 수 있도록 등판 라인을 조절 할 수 있습니다.
*DFB System 셋팅하는 방법 : 등판 하단을 잡고 위로 올려 '딸각'소리에 멈춥니다. 끝까지 올리면 다시 초기 상태로 돌아갈 수 있습니다.
- 2 좌판 우측 아래에 위치한 레버를 사용하여 좌판을 밀고 당겨 깊이를 조절 할 수 있습니다. 허리가 등판에 닿는 위치로 맞춰 사용하면 피로도를 최소화시켜 줍니다.
- 3 헤드레스트를 위/아래로 밀고 당겨 사용자의 신장에 맞춰 헤드 높낮이를 조절할 수 있습니다.
- 4 고탄성 메쉬는 높은 탄성으로 착석감을 올려주고 충분한 통기성을 확보하여 장시간 사용에도 최적의 안락감을 느끼게 해 줍니다.

- 1 By using the DFB System (Dynamic Fitting Back System), which is a functional adjusting backboard, the user can adjust the backboard line fit it to the user's waist.
* How to set the DFB System: Hold the bottom of the backboard and hold it up until it makes a "clicking" sound. If you hold it up to the end, you can return it to the initial state.
- 2 You can adjust the depth by pushing and pulling the seat using the lever located at the bottom right of the seat. Use it to match the position of the waist against the backboard to minimize a sense of fatigue.
- 3 The user can adjust the height of the headrest according to the user's height by pushing and pulling the headrest up / down.
- 4 Highly elastic mesh gives a great feeling of coziness when the user is in the seat and ensures sufficient ventilation to provide a feeling of comfort.



헤드레스트형 HEADREST TYPE



등좌판 메쉬타입 Mesh Seat
TOH55952MWWGY
W625 D 630-680
H 1170-1285



등판 메쉬, 좌판 패브릭 타입 Fabric Seat
TOH55952W
W625 D 630-680
H 1170-1285

미들백형 MID-BACK TYPE



등좌판 메쉬타입 Mesh Seat
TOH55932MWWGY
W625 D 630-680
H 995-1085



등판 메쉬, 좌판 패브릭 타입 Fabric Seat
TOH55932W
W625 D 630-680
H 995-1085

머리받이 높이조절 Headrest Height Adjustment	이중바퀴 구조의 우레탄 캐스터 Dual Wheel Urethane Caster	싱크로나이즈드 틸트 Synchronized Tilt	다중틸트 고정장치 Multi-Locking	틸트 강도조절 Tilting Strength Adjustment
가스식 높낮이조절 Gas Spray Seat Height Adjustment	팔걸이 전-후조절 Arm Pads Back and Forth Adjustment	가스식 높낮이조절 Gas Spray Seat Height Adjustment	좌판 깊이조절 Seat Depth Adjustment	팔걸이 높이조절 Armrest Height Adjustment
다이내믹 피팅 백 시스템 Dynamic Fitting Back System				

T554G

현대의 사무환경에 꼭 필요한 T554G. 바른 자세를 유지하도록 도와주는 인체공학적 설계와 다양한 기능들로 편안한 착석감을 제공함은 물론 업무 능률도 향상시킵니다.

Best-suited to the modern work environment of any type.

The ergonomic design of T554G helps the user to maintain a good posture. Combined with diverse features, it not only provides comfort to the user but also improves work efficiency considerably.

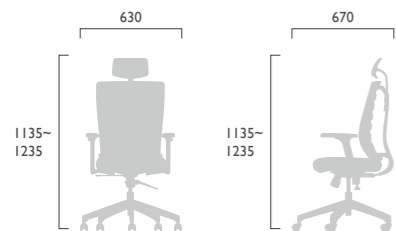

Color / Material

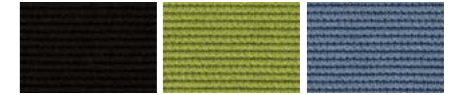

등판 BACK / 좌판 SEAT

BK(CF5541)
FABRIC

GN(CF5542)
FABRIC

LB(CF5544)
FABRIC

- 1 인체의 움직임에 맞추어 등판과 좌판이 각기 다른 각도로 틸팅되는 싱크로나이즈드 틸팅기능과 등판의 기울기가 5단계로 조절되는 멀티 락킹 틸팅기능을 갖추었습니다.
- 2 헤드레스트는 사용자의 경추부를 탄력있게 받쳐주어 피로도를 낮춰주며 앉은 키에 맞게 높낮이 조절이 가능합니다.
- 3 Response Back Technology 기능으로 착석시 바른 자세를 유도하여 장시간 착석시 피로도를 최소화 합니다.
- 4 높이조절과 전·후·좌·우 조절 기능을 적용한 팔걸이는 사용자가 원하는 높이와 위치를 조절할 수 있습니다.

- 1 The backrest and seat tilt in a synchronized way according to a user's movements. And it has a multi-locking tilt function to fix the backrest at the desired angle through 5 reclining stages.
- 2 The headrest provides the user with resilient support for his/her cervical spine. It reduces the user's fatigue. It can be adjusted vertically according to the user's sitting height.
- 3 The feature based on the Response Back Technology encourages the user to maintain a desirable posture so that the user can minimize fatigue even during prolonged sitting.
- 4 The armrest is equipped with the vertical and horizontal adjustment (moving forward·backward·left-right) feature in order for the user to choose the most appropriate height and direction.



Seating Task T554G

헤드레스트형 HEADREST TYPE

좌판길이 조절형
Seat Depth Adjustment Type
TOH 55452D
W630 D670 H1135~1235

좌판길이 고정형
Seat Depth Fixed Type
TOH 55452
W630 D670 H1135~1235



미들백형 MID-BACK TYPE

좌판길이 조절형
Seat Depth Adjustment Type
TOH 55432D
W630 D670 H995~1095

좌판길이 고정형
Seat Depth Fixed Type
TOH 55432
W630 D670 H995~1095



- 머리받이 높이조절 Headrest Height Adjustment
- 싱크로나이즈드 틸팅 Synchronized Tilt
- 팔걸이 폭조절 Armrest Width Adjustment

- 머리받이 회전기능 Headrest Adjustment : Rotation
- 다중 틸트 고정장치 Multi-Locking
- 가스식 높낮이조절 Gas Spray Seat Height Adjustment

- 이중바퀴 구조의 우레탄 캐스터 Dual Wheel Urethane Caster
- 틸트 강도조절 Tilting Strength Adjustment
- 좌판 깊이조절 Seat Depth Adjustment

- 등판 리클라인 기능 Back Recline Angle Adjustment
- 팔걸이 높이조절 Armrest Height Adjustment

- 팔걸이 전·후조절 Arm Pads Back and Forth Adjustment

T503G

사무공간을 한층 부드럽고 편안하게 만들어 주는 T503 메쉬 소재를 적용한 등판, 좌판으로 쾌적하며, 다양한 기능으로 장시간 근무에도 편안함을 제공합니다
T503 makes the workspace cozier and more comfortable. Its mesh-based backrest and seat coupled with diverse features guarantee user comfort even during long hours of office work.

Color / Material



등판 BACK / 좌판 SEAT

DB(CM5531) MESH	GY(CM5532) MESH	MB(CM5533) MESH
--------------------	--------------------	--------------------

- 1 사용자의 체형에 따라 높낮이 조절이 가능하며 자체 텐션은 미세한 움직임에도 목을 편하게 지지해 줍니다.(30mm)
 - 2 높이 조절과 좌우 회전 기능을 적용한 팔걸이는 사용자가 원하는 높이와 위치를 조절할 수 있습니다.
 - 3 등판과 좌판을 각기 다른 각도로 움직이는 싱크로나이즈드 틸팅을 적용하였습니다.
 - 4 좌판 측면에 위치한 레버를 이용하여 좌판의 깊이를 조절하여 사용할 수 있습니다.
- 1 Users can adjust the height. Its self-tension feature ensures the comfort of users' necks even during minimal user movement(30mm).
 - 2 The armrest is equipped with vertical and horizontal adjustment features that enable users to choose their favorite height and position.
 - 3 It is equipped with a synchro tilt feature that enables the backrest and the seat to move in different directions.
 - 4 The user can change the depth of the seat with the lever situated on the left of the seat.

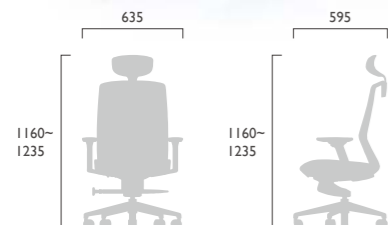
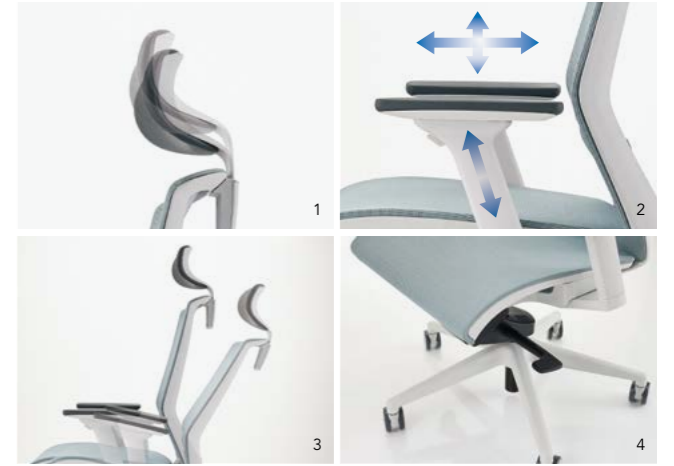

헤드레스트형 HEADREST TYPE



팔걸이 조절형
Armrest Adjustment Type
TOH 50352L
W635 D595 H1160-1235



팔걸이 고정형
Armrest Fixed Type
TOH 50350L
W625 D595 H1160-1235

미들백형 MID -BACK TYPE



팔걸이 조절형
Armrest Adjustment Type
TOH 50332L
W635 D575 H985-1060



팔걸이 고정형
Armrest Fixed Type
TOH 50330L
W625 D575 H985-1060

머리받이 높이조절 Headrest Height Adjustment	머리받이 프리텐션 Headrest Free Tension	이중바퀴 구조의 우레탄 캐스터 Dual Wheel Urethane Caster	허리받침 높이조절 Lumbar Support Height Adjustment	싱크로나이즈드 틸트 Synchronized Tilt
다중 락 고정장치 Multi-Locking	틸트 강도조절 Tilting Strength Adjustment	팔걸이 높이조절 Armrest Height Adjustment	팔걸이 전-후조절 Arm Pads Back and Forth Adjustment	팔걸이 폭조절 Armrest Width Adjustment
가스식 높낮이조절 Gas Spray Seat Height Adjustment	좌판 깊이조절 Seat Depth Adjustment			

3600G

친환경 소재의 효율적인 사용과 사방형 구조 디자인으로 내구성이 뛰어나며, 사용자의 취향에 따라 메쉬와 패드타입 등판을 선택할 수 있습니다.

Environment friendly and squarely shaped, it secures excellent endurance and offers options of mesh or pad type.



한국산업디자인상
Korea Industrial
Design Awards



굿디자인
GOOD
DESIGN



BIFMA
MEMBER
(Business & Institutional
Furniture Manufacturer's
Association)

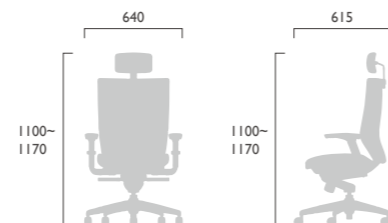

	Color / Material				
등판 BACK	BK(CM361) MESH	BK(CM361) MESH	BU(CM362) MESH	YE(CM362) MESH	BLACK FABRIC
좌판 SEAT	BLACK FABRIC	BLACK ARTIFICIAL LEATHER	BLACK FABRIC	BLACK FABRIC	BLACK FABRIC

메쉬형(인조가죽) MESH TYPE(ARTIFICIAL LEATHER)



OH 3652NLMA
W640 D615 H1100-1170

좌판 인조가죽형은 등판 메쉬 컬러를 CM361만 운영합니다.
Artificial leather seat boards are operated with only CM361 mesh.



OH 3632NLMA
W640 D590 H995-1065

좌판 인조가죽형은 등판 메쉬 컬러를 CM361만 운영합니다.
Artificial leather seat boards are operated with only CM361 mesh.

메쉬형(패브릭) MESH TYPE(FABRIC)



OH 3652NLM
W640 D615 H1100-1170



OH 3632NLM
W640 D590 H995-1065

패드형 PAD TYPE



OH 3652NLF
W640 D615 H1100-1170



OH 3632NLF
W640 D590 H995-1065



- 1 사용자의 미세한 자세 교정이 가능하도록 머리받이 각도와 높이를 조절할 수 있습니다.
- 2 인체의 움직임에 맞추어 등판과 좌판이 각기 다른 각도로 틸팅되는 싱크로나이즈드 틸팅기능과 등판의 기울기가 5단계로 조절되는 멀티락킹 틸팅기능을 갖추었습니다.

- 1 Minor adjustment of position with the headrest tilting and height adjustment.
- 2 The backrest and seat tilt in a synchronized way according to a user's movements, And it has a multi-locking tilt function to fix the backrest at the desired angle through 5 reclining stages.

머리받이 높이조절 Headrest Height Adjustment	머리받이 회전기능 Headrest Adjustment : Rotation	이중바퀴 구조의 우레탄 캐스터 Dual Wheel Urethane Caster	허리받침 높이조절 Lumbar Support Height Adjustment	좌판 깊이조절 Seat Depth Adjustment
싱크로나이즈드 틸트 Synchronized Tilt	다중 틸트 고정장치 Multi-Locking	틸트 강도조절 Tilting Strength Adjustment	가스식 높낮이조절 Gas Spray Seat Height Adjustment	팔걸이 높이조절 Armrest Height Adjustment

* 친환경 소재를 사용하고, 재활용 및 폐기를 위해 재료의 분리가 용이하도록 구조 설계되었습니다. 또한, 비철금속을 활용한 부품에 재료명을 표기하고 있습니다.
* Environment-friendly materials are used and their separation is easy for recycling and disposal. The material name is marked on the parts made of nonferrous metal.

T501G

세련되고 유연성이 뛰어난 메쉬 등판과 인체의 구조를 고려하여 디자인된 유려한 곡선미가 돋보이는 T501G. 자연스러우면서도 절제되고 역동적인 디자인을 통해 현대 사무용 의자의 기준을 제시하여 드립니다.

The T501G offers stylishly curved lines with a mesh back and an attractive ergonomic design for the highest level of comfort. Its modern, dynamic look establishes a new and higher standard for office chairs.

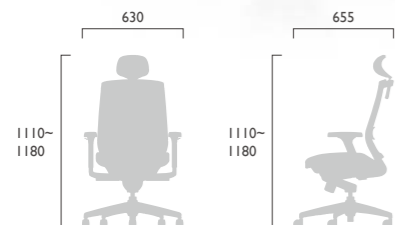

	Color / Material			
등판 BACK				
좌판 SEAT				
	BUJ(CM5011) MESH	GNIC(CM5012) MESH	GY(CM5013) MESH	BK(CM5014) MESH
	BU(CF5011) FABRIC	GN(CF5012) FABRIC	GY(CF5013) FABRIC	BK(CF5014) FABRIC



- 1 요추지지대는 착석시 허리를 받쳐주어 편안하며 사용자의 체형과 업무 스타일에 따라 상하로 40mm 높이 조절이 가능합니다.
- 2 의자의 등받이가 젖혀지는 각도는 5단계로 고정할 수 있는 락킹 기능을 갖추고 있어, 원하는 각도로 고정할 수 있습니다.
- 3 사용자의 체형과 업무스타일에 따라 좌판 깊이를 5단계(50mm)로 조절하여 편리합니다.
- 4 팔걸이 전후좌우 조절이 가능하여 업무 환경에 따라 팔걸이 위치를 조절할 수 있습니다.
- 5 사용자의 체형에 맞게 넥레스트의 높낮이를 간편하게 상하로 70mm를 조절할 수 있습니다.

- 1 The adjustable lumbar support provides adequate support for the back, allowing users to raise or lower it up to 40mm according to their posture and work style.
- 2 The backrest with 5-level tilt lock adjustment allows users to conveniently change the angle of the backrest.
- 3 Users can adjust the depth of the seat at 5 different levels (up to 50mm) in accordance with their body posture and preferred work style.
- 4 The armrest can be adjusted by width and location in accordance with users' body posture and preferred work style.
- 5 Users can raise or lower the neckrest up to 70mm to suit their body posture.

메쉬형 MESH TYPE

통기성과 탄력성이 뛰어난 메쉬 등판으로 제작되었으며 편안한 구조와 다양하고 뛰어난 기능을 갖추고 있는 미래형 사무용 의자입니다.

The mesh backpiece has excellent ventilation and elasticity. It is an office chair for the future combining a comfortable structure and a variety of functions.



헤드레스트+코트행거+요추지지형
Headrest+Coat Hanger+
Lumbar Support Type
TOH 50172NL
W630 D655 H1110~1180

코트행거+요추지지형
Coat Hanger+
Lumbar Support Type
TOH 50162NL
W630 D655 H995~1065

헤드레스트+요추지지형
Headrest+
Lumbar Support Type
TOH 50152NL
W630 D605 H1110~1180

미들백+요추지지형
Mid-Back+
Lumbar Support Type
TOH 50132NL
W630 D605 H950~1020

헤드레스트+코트행거형
Headrest+Coat Hanger Type
TOH 50172N
W630 D655 H1110~1180

코트행거형
Coat Hanger Type
TOH 50162N
W630 D655 H995~1065

헤드레스트형
Headrest Type
TOH 50152N
W630 D605 H1110~1180

미들백형
Mid-Back Type
TOH 50132N
W630 D605 H950~1020

머리받이 높이조절 Headrest Height Adjustment	이중바퀴 구조의 우레탄 캐스터 Dual Wheel Urethane Caster	싱크로나이즈드 틸트 Synchronized Tilt	틸트 강도조절 Tilting Strength Adjustment	다중 틸트 고정장치 Multi-Locking
팔걸이 높이조절 Armrest Height Adjustment	팔걸이 각도조절 Arm Pads Angle Adjustment	팔걸이 전-후조절 Arm Pads Back and Forth Adjustment	가스식 높낮이조절 Gas Spray Seat Height Adjustment	좌판 깊이조절 Seat Depth Adjustment
허리받침 높이조절 Lumbar Support Height Adjustment				

TASK

T553G

인체공학적 설계와 다양한 사용자 중심의 기능을 적용한 T553G는 사용자의 체형에 따른 맞춤형 의자를 만들어주어 최적의 사무환경을 조성합니다. T553G is equipped with ergonomic design and diverse user-centered features, which enable the user to actually customize the chair to his/her body and create an optimized work environment.

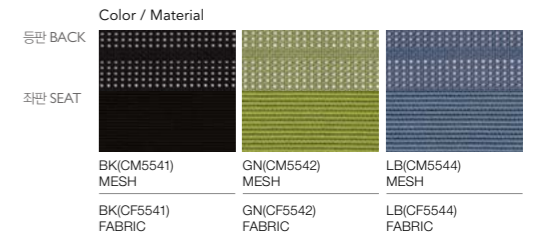
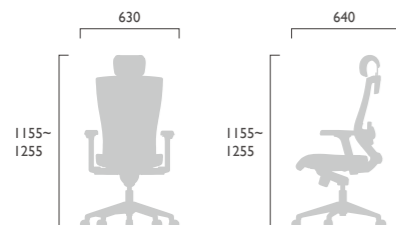

- 1 인체의 움직임에 맞추어 등판과 좌판이 각기 다른 각도로 틸팅되는 싱크로나이즈드 틸팅기능과 등판의 기울기가 5단계로 조절되는 멀티락킹 틸팅기능을 갖추었습니다.
- 2 사용자의 체형에 맞게 헤드레스트의 높낮이를 간편하게 조절할 수 있으며, 옵션 코트 행거로 편의성을 더했습니다.
- 3 사용자의 체형에 맞도록 요추지지의 위치를 조절할 수 있습니다.
- 4 단계별로 높낮이 조절이 가능하며 팔걸이를 원하는 위치에 고정할 수 있습니다.

- 1 The backrest and seat tilt in a synchronized way according to a user's movements. And it has a multi-locking tilt function to fix the backrest at the desired angle through 5 reclining stages.
- 2 The headrest is easily adjustable vertically depending on the user's body type. The optional coathanger adds to the user's convenience.
- 3 A user can adjust the position with the movable lumbar support.
- 4 The height of the armrest can be vertically adjusted according to each level.



헤드레스트+코트행거형
HEADREST+COAT HANGER TYPE



팔걸이 조절+요추지지형
Armrest Adjustment+
Lumbar Support Type
TOH 55362LWGY
W630 D690 H1170-1270

팔걸이 조절형
Armrest Adjustment Type
TOH 55362WGY
W630 D690 H1170-1270



팔걸이 조절+요추지지형
Armrest Adjustment+
Lumbar Support Type
TOH 55372LB
W630 D690 H1155-1255

팔걸이 조절형
Armrest Adjustment Type
TOH 55372B
W630 D690 H1155-1255

팔걸이 고정+요추지지형
Armrest Fixed+
Lumbar Support Type
TOH 55370LB
W630 D690 H1155-1255

팔걸이 고정형
Armrest Fixed Type
TOH 55370B
W630 D690 H1155-1255

헤드레스트형
HEADREST TYPE



팔걸이 조절+요추지지형
Armrest Adjustment+
Lumbar Support Type
TOH 55352LB
W630 D640 H1155-1255

팔걸이 조절형
Armrest Adjustment Type
TOH 55352B
W630 D640 H1155-1255

팔걸이 고정+요추지지형
Armrest Fixed+
Lumbar Support Type
TOH 55350LB
W630 D640 H1155-1255

팔걸이 고정형
Armrest Fixed Type
TOH 55350B
W630 D640 H1155-1255

미들백형
MID-BACK TYPE



팔걸이 조절+요추지지형
Armrest Adjustment+
Lumbar Support Type
TOH55332LB
W630 D640 H995-1095

팔걸이 조절형
Armrest Adjustment Type
TOH 55332B
W630 D640 H995-1095

팔걸이 고정+요추지지형
Armrest Fixed+
Lumbar Support Type
TOH 55330LB
W630 D640 H995-1095

팔걸이 고정형
Armrest Fixed Type
TOH 55330B
W630 D640 H995-1095

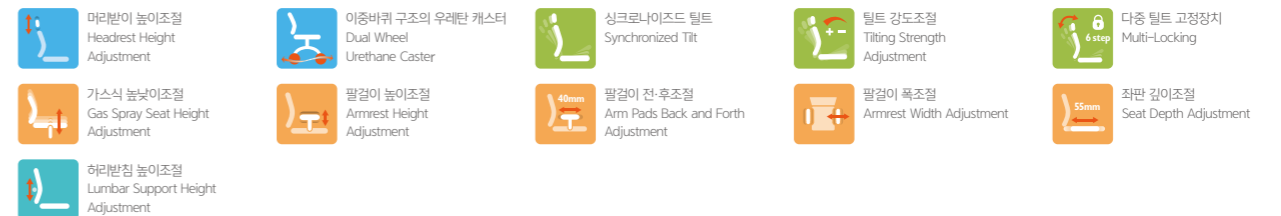

4300G

세련된 라인의 등판 곡선에 통기성과 신축성이 우수한 메쉬를 씌워 자연스러운 편안함을 드립니다.

A highly permeable and flexible mesh cover with smooth curve lines on the back provides natural comfort.

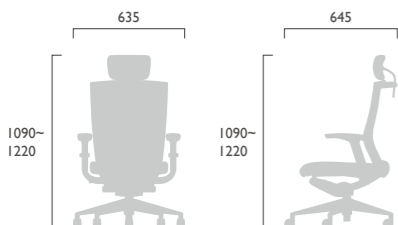

	Color / Material		
등판 BACK			
좌판 SEAT			

- 1 인체의 움직임에 맞추어 등판과 좌판이 각기 다른 각도로 틸팅되는 싱크로나이즈드 틸팅기능과 등판의 기울기가 4단계로 조절되는 멀티락킹 틸팅기능을 갖추었습니다.
 - 2 사용자의 체형에 맞도록 요추지지의 위치를 조절할 수 있습니다.
- 1 The backrest and seat tilt in a synchronized way according to a user's movements. And it has a multi-locking tilt function to fix the backrest at the desired angle through 9 reclining stages.
 - 2 A user can adjust the position with the movable lumbar support.



팔걸이 조절형 ARMREST ADJUSTMENT TYPE



- | | | | |
|---|---|--|---|
| <p>헤드레스트+요추지지형
Headrest+
Lumbar Support Type
OH 4352LS
W635 D645 H1090-1220</p> | <p>헤드레스트형
Headrest Type
OH 4352S
W635 D645 H1090-1220</p> | <p>요추지지형
Lumbar Support Type
OH 4332LS
W635 D610 H945-1075</p> | <p>기본형
Standard Type
OH 4332S
W635 D610 H945-1075</p> |
|---|---|--|---|

팔걸이 고정형 ARMREST FIXED TYPE



- | | | | |
|---|---|--|---|
| <p>헤드레스트+요추지지형
Headrest+
Lumbar Support Type
OH 4350LS
W635 D645 H1090-1220</p> | <p>헤드레스트형
Headrest Type
OH 4350S
W635 D645 H1090-1220</p> | <p>요추지지형
Lumbar Support Type
OH 4330LS
W635 D610 H945-1075</p> | <p>기본형
Standard Type
OH 4330S
W635 D610 H945-1075</p> |
|---|---|--|---|

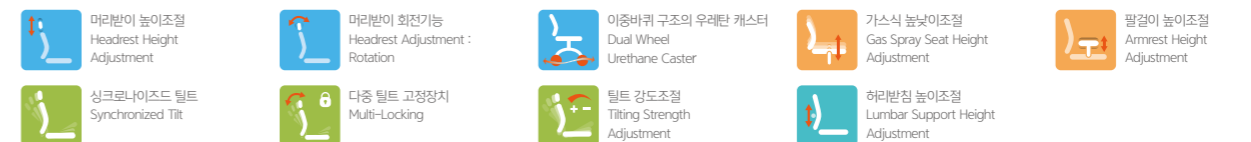

T555G

다양한 사무환경에 맞출 수 있는 등받이 메쉬형과 패딩형 옵션 의자로서, 편안한 착석감과 함께 업무공간의 유연한 분위기를 연출합니다.

To match diverse work environment, T555G comes in a mesh type backrest and a padded backrest. This extremely comfortable chair helps create a flexible work environment.

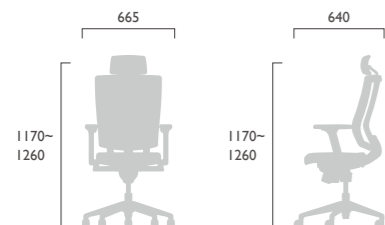

	Color / Material		
등받이 BACK			
좌판 SEAT			
	BK(CM5541) MESH	GN(CM5542) MESH	LB(CM5544) MESH
	BK(CF5541) FABRIC	GN(CF5542) FABRIC	LB(CF5544) FABRIC

- 1 요추지지대의 전후 링크기능은 항상 요추를 지지하여 줌으로써 안락감을 제공합니다.
- 2 인체의 움직임에 맞추어 등판과 좌판이 각기 다른 각도로 틸팅되는 싱크로나이즈드 틸팅기능과 등판의 기울기가 5단계로 조절되는 멀티 락킹 틸팅기능을 갖추었습니다.
- 3 등판은 패드와 메쉬로 선택가능하며, 메쉬는 충분한 통기성을 확보하여 장시간 착석해도 최적의 안락감을 느끼게 해줍니다.
- 4 헤드레스트는 사용자의 경추부를 탄력있게 받쳐주어 피로도를 낮춰주며 앉은 키에 맞게 높낮이 조절과 회전기능이 가능합니다.

- 1 The movable link feature of the back support continues to back up the user's spine to maximize comfort.
- 2 The backrest and seat tilt in a synchronized way according to a user's movements. And it has a multi-locking tilt function to fix the backrest at the desired angle through 5 reclining stages.
- 3 The user can choose either a padded backrest or a mesh backrest. The latter enables the user to enjoy a maximum of comfort even during protracted sitting through its ample air permeability.
- 4 The headrest provides a resilient support for the user's cervical spine and reduces fatigue. It can be adjusted vertically to fit the user's sitting height and be adjusted forward or backward, too.

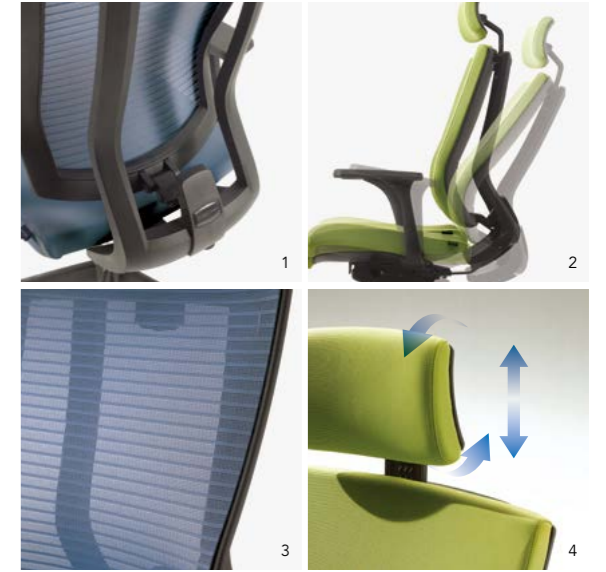

Seating Task T555G

패딩형 PAD TYPE



팔걸이 조절형
Armrest Adjustment Type
TOH 55552P
W665 D640 H1170~1260

팔걸이 고정형
Armrest Fixed Type
TOH 55550P
W665 D640 H1170~1260



팔걸이 조절형
Armrest Adjustment Type
TOH 55532P
W665 D640 H1020~1110

팔걸이 고정형
Armrest Fixed Type
TOH 55530P
W665 D640 H1020~1110

메쉬형 MESH TYPE



팔걸이 조절형
Armrest Adjustment Type
TOH 55552M
W665 D640 H1170~1260

팔걸이 고정형
Armrest Fixed Type
TOH 55530M
W665 D640 H1170~1260



팔걸이 조절형
Armrest Adjustment Type
TOH 55532M
W665 D640 H1020~1110

팔걸이 고정형
Armrest Fixed Type
TOH 55530M
W665 D640 H1020~1110

머리받이 높이조절 Headrest Height Adjustment	머리받이 회전기능 Headrest Adjustment : Rotation	이중바퀴 구조의 우레탄 캐스터 Dual Wheel Urethane Caster	등판 프리텐션 Backrest Free Tention	등판 플렉서블 서포트기능 Backrest Flexible Support Mechanisms
싱크로나이즈드 틸트 Synchronized Tilt	틸트 강도조절 Tilting Strength Adjustment	다중 틸트 고정장치 Multi-Locking		
가스식 높낮이조절 Gas Spray Seat Height Adjustment	팔걸이 높이조절 Armrest Height Adjustment	팔걸이 전-후조절 Arm Pads Back and Forth Adjustment	팔걸이 폭조절 Armrest Width Adjustment	

TASK

T302G

다양한 컬러와 무광택의 화이트 프레임의 조화로 산뜻한 사무 공간을 연출합니다. 또한 매력적인 사각 프레임으로 사용자의 개성을 더욱 돋보이게 하며, 통기성과 신축성이 우수한 메쉬소재로 자연스러운 편안함을 드립니다.

With its range of colors combined pure white frames, this product is perfect for the creation of a refreshing office environment.

Attractive square frames highlight the user's character.

The mesh material ensures excellent air permeability and flexibility, delivering a "natural comfort" to the user.

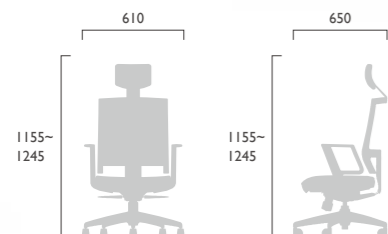

	Color / Material			
등판 BACK				
좌판 SEAT				
	GN(CM3021) MESH	BU(CM3022) MESH	LB(CM3003) MESH	BR(CM3024) MESH
	GN(CF3021) FABRIC	BU(CF3022) FABRIC	LB(CF3003) FABRIC	BR(CF3024) FABRIC



- 1 사용자의 체형에 맞게 헤드레스트의 높낮이를 간편하게 상하로 조절할 수 있습니다.
1 The height of the headrest is easily adjustable according to the user's body type.
- 2 인체의 움직임에 맞추어 등판과 좌판이 각기 다른 각도로 틸팅되는 싱크로나이즈드 틸팅기능과 등판의 기울기가 4단계로 조절되는 멀티 락킹 틸팅기능을 갖추었습니다.
2 The backrest and seat tilt in a synchronized way according to a user's movements. And it has a multi-locking tilt function to fix the backrest at the desired angle through 4 reclining stages.
- 3 사용자의 체형에 맞게 뒤로 젖혀지는 등판의 강도를 조절할 수 있으며 사용자의 체형에 따라 레버를 이용하여 의자 높낮이를 조절할 수 있습니다.
3 The amount of force required to recline to the user's weight is adjustable. According to the user's body type, the seat pan height can be easily changed with the operation of a lever.

헤드레스트+코트행거형
HEADREST+
COAT HANGER TYPE



TOH 30270
W610 D650 H1155~1245

미들백+코트행거형
MID-BACK+
COAT HANGER TYPE



TOH 30260
W610 D640 H970~1060

헤드레스트형
HEADREST TYPE



TOH 30250
W610 D600 H1155~1245

미들백형
MID-BACK TYPE



TOH 30230
W610 D590 H925~1015

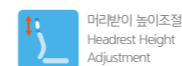

머리받이 높이조절
Headrest Height
Adjustment

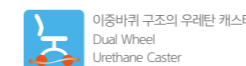

이중바퀴 구조의 우레탄 캐스터
Dual Wheel
Urethane Caster



싱크로나이즈드 틸트
Synchronized Tilt

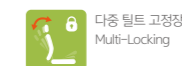

다중 락킹 고정장치
Multi-Locking

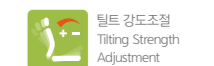

틸트 강도조절
Tilting Strength
Adjustment



가스식 높낮이조절
Gas Spray Seat Height
Adjustment

T353G

탄성이 좋은 메쉬를 소재로 제품의 형태를 그대로 유지시켜주며, 화이트와 블랙 프레임으로 공간의 분위기에 맞게 색상을 선택할 수 있습니다. 투톤 패브릭으로 고급스러운 컬러는 물론 따뜻하고 편안한 분위기를 연출해줍니다.

The highly elastic mesh keeps the shape of the product and you can choose the color white or black frame to match the atmosphere of the space. Two-tone fabric presents luxurious colors while also providing a warm and comfortable atmosphere.

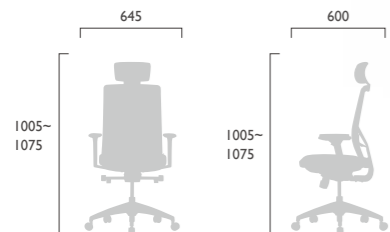

틸트 조절 Tilt Adjustment



일반형 틸트

- 1) 틸트 강도 조절 방법 : 의자 하부 틸트 가운데에 위치한 원통 핸들을 좌/우로 돌려 틸트 강도를 조절합니다.
- 2) 틸트 LOCK 방법 : 좌판 아래 틸트(의자 착석 시) 좌측 손잡이를 이용하여 원하는 의자 틸팅 각도에서 고정시킬 수 있습니다.
- 3) 의자 높낮이 조절 방법 : 좌판 아래 틸트(의자 착석 시) 우측 손잡이를 이용하여 원하는 만큼 의자 높낮이를 조절할 수 있습니다.

General Tilt Type

- 1) How to adjust the tilt intensity: Adjust the tilt intensity by turning the cylinder handle located in the low center of the chair to left / right.
- 2) Tilt LOCK method: You can fix the chair's tilt angle at the desired angle by using the left knob below the seat (when sitting on the chair).
- 3) How to adjust the height of the chair: You can adjust the height of the chair as much as you want by using the right knob of the tilt under the seat (when sitting on the chair).

셀프텐션형 틸트

- 1) 틸트 강도 조절 방법 : 셀프텐션 틸트로 사용자의 하중에 비례해서 자동으로 틸트 강도가 조절되지만, 사용자의 기호에 따라 틸트 강도를 세밀하게 조절할 수 있도록 별도로 3단계 강도조절 기능을 제공합니다. 의자 착석 시 오른쪽 레버를 회전시켜 조절합니다.
- 2) 틸트 LOCK 방법 : 원하는 틸팅 각도에서 4단계 고정시킬 수 있습니다. 의자 틸팅 후 왼쪽 레버를 앞으로 돌려서 고정, 의자 등판을 밀면서 레버를 뒤쪽으로 돌려서 해제합니다.
- 3) 의자 높낮이 조절 방법 : 좌판 아래 틸트의 우측 손잡이를 이용하여 원하는 만큼 의자 높낮이를 조절할 수 있습니다.

Self Tension Tilt Type

- 1) How to adjust the tilt intensity: Self-tension tilt automatically adjusts the tilt intensity in proportion to the user's weight, but it also provides 3-step intensity adjustment function to allow users to adjust the tilt intensity according to the user's preference. Rotate the right lever to adjust when sitting on a chair.
- 2) Tilt LOCK method: You can fix the desired tilt angle through 4 steps. After tilting the chair, turn the left lever to the front to fix it, push the chair backboard and turn the lever backward to release it.
- 3) How to adjust the height of the chair: You can adjust the height of the chair as much as you want by using the right knob of the tilt under the seat.

팔걸이 조절 Armrest Adjustment

사용자가 편하게 사용할 수 있는 기본 높이를 제공합니다. Made in a default height that makes users feel comfortable.



- 1 의자에 앉을 때 가장 중요한 허리를 받쳐주는 요추지지대의 높낮이를 조절하여편안한 착석감을 제공합니다.
- 2 좌판 좌측 아래에 위치한 레버를 사용하여 좌판을 밀고 당겨 깊이를 조절 할 수 있습니다. 의자에 앉은 상태에서 엉덩이로 좌판을 밀고 당긴 후 허리가 등판에 닿는위치로 맞춰 레버를 상하로 움직여 고정, 해제합니다.

- 1 The seat is adjustable depending on the user's body. The armrest can be adjusted vertically in stages according to the user's preference.
- 2 The backrest and seat tilt in a synchronized way according to a user's movements. And it has a multi-locking tilt function to fix the backrest at the desired anglethrough 5 reclining stages.



머리받이 높이조절 Headrest Height Adjustment	이중바퀴 구조의 우레탄 캐스터 Dual Wheel Urethane Caster	허리받침 높이조절 Lumbar Support Height Adjustment	6 단계 틸트 고정장치 Multi-Locking	싱크로나이저드 틸트 Synchronized Tilt
틸트 강도조절 Tilting Strength Adjustment	팔걸이 높이조절 Armrest Height Adjustment	팔걸이 각도조절 Arm Pads Angle Adjustment	가스식 높낮이조절 Gas Spray Seat Height Adjustment	팔걸이 전-후조절 Arm Pads Back and Forth Adjustment
좌판 깊이조절 Seat Depth Adjustment				

화이트 체어 WHITE CHAIR

Color / Material	
등받이 BACK	GY(CF3531) MESH
좌판 SEAT	GY(CF3531) FABRIC
	GY(CF3531) MESH
	BE(CF3532) FABRIC

1 일반형 틸트 GENERAL TILT TYPE 미들백형 MID-BACK TYPE



고정 팔걸이형
Armrest Fixed Type
TOH35330LWC
W645 D 565 H 985-1080

조절 팔걸이형
Armrest Adjustment Type
TOH35332LWC
W645 D 565 H 985-1080

헤드레스트형 HEADREST TYPE



고정 팔걸이형
Armrest Fixed Type
TOH35350LWC
W645 D 565 H 1160-1285

조절 팔걸이형
Armrest Adjustment Type
TOH35352LWC
W645 D 565 H 1160-1285

2 셀프텐션형 틸트 SELF TENSION TILT TYPE 미들백형 MID-BACK TYPE



고정 팔걸이형
Armrest Fixed Type
TOH35330LWP
W645 D 590 H 1005-1075

조절 팔걸이형
Armrest Adjustment Type
TOH35332LWP
W645 D 590 H 1005-1075

헤드레스트형 HEADREST TYPE



고정 팔걸이형
Armrest Fixed Type
TOH35350LWP
W645 D 565 H 1160-1285

조절 팔걸이형
Armrest Adjustment Type
TOH35352LWP
W645 D 565 H 1160-1285

3 회의용 CONFERENCE TYPE



TOH35390WGY
W645 D 650 H 1020

블랙 체어 BLACK CHAIR

Color / Material		
등받이 BACK	BK(CF3533) MESH	BK(CF3533) MESH
좌판 SEAT	BK(CF3533) FABRIC	GN(CF3534) FABRIC
	BK(CF3533) MESH	BU(CF3535) FABRIC

1 일반형 틸트 GENERAL TILT TYPE 미들백형 MID-BACK TYPE



고정 팔걸이형
Armrest Fixed Type
TOH35330LC
W645 D 565 H 985-1080

조절 팔걸이형
Armrest Adjustment Type
TOH35332LC
W645 D 565 H 985-1080

헤드레스트형 HEADREST TYPE



고정 팔걸이형
Armrest Fixed Type
TOH35350LC
W645 D 565 H 1160-1285

조절 팔걸이형
Armrest Adjustment Type
TOH35352LC
W645 D 565 H 1160-1285

2 셀프텐션형 틸트 SELF TENSION TILT TYPE 미들백형 MID-BACK TYPE



고정 팔걸이형
Armrest Fixed Type
TOH35330LP
W645 D 590 H 1005-1075

조절 팔걸이형
Armrest Adjustment Type
TOH35332LP
W645 D 590 H 1005-1075

헤드레스트형 HEADREST TYPE



고정 팔걸이형
Armrest Fixed Type
TOH35350LP
W645 D 600 H 1180-1275

조절 팔걸이형
Armrest Adjustment Type
TOH35352LP
W645 D 600 H 1180-1275

3 회의용 CONFERENCE TYPE



TOH35390BBK
W645 D 650 H 1020

T557G

장시간 사무실에 근무하는 사용자를 위해 통기성이 우수한 매쉬 소재를 사용하였습니다. 깔끔하고 짜임새 있는 간결한 디자인으로 다양한 공간에서 활용하기 좋은 기능성 의자입니다.

Breathable mesh material is applied for user who stays long time in office. Clean and simple design matches various office environment.

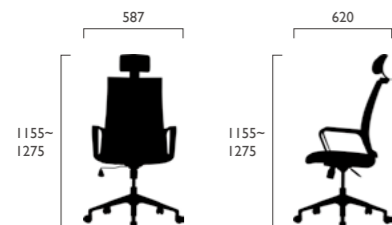

Color / Material	
등판 BACK	
좌판 SEAT	
	BK(CM5571) MESH
	BK(CF5571) FABRIC

- 1 등판에 적용한 요추지지대는 착석 시 허리를 펼 수 있게 도와 바른 자세를 유지할 수 있게 해줍니다.
- 2 좌측 조절 손잡이를 이용하여 원하는 의자높이만큼 조절할 수 있으며 손잡이를 푸쉬/풀하여 등판 틸팅 고정 가능하므로 다양한 업무 환경에 적합한 기능을 제공합니다.
- 3 등판과 좌판이 고정된 상태에서 틸팅되는 니틸팅을 적용하였습니다.
- 4 등판과 좌판에 연결되어 있는 고정 팔걸이는 사각형 형태의 의자와 조화를 이루며 시각적으로 견고함과 안정감을 느끼게 해줍니다.

- 1 Lumbar supporter applied in back helps user keeps correct posture.
- 2 Height adjustable function and tilting holding function.
- 3 Tilted when back and seat is fixed.
- 4 Square armrest harmonizes with square shape back and provides visual stability and solidity.



헤드레스트형
HEADREST TYPE



TOH 55750LB
W587 D620 H1155-1275

미들백형
MID-BACK TYPE



TOH 55730LB
W587 D605 H978-1095

로우백형
LOW-BACK TYPE



TOH 55720LB
W587 D605 H910-1030

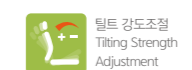

MULTI-USE

400G

회의실, 세미나실, 교육실 등 어떠한 장소에서도 공간연출이 자유로우며, 등받이 틸팅 설계로 최상의 착석감을 유도합니다.

The products can fit into any kinds of rooms, including conference rooms, seminar rooms and lecture rooms. With tilting backrests, they guarantee the highest level of comfort.

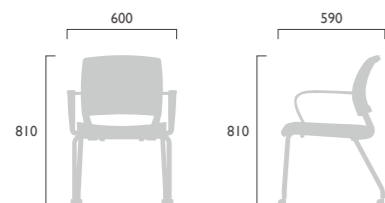

Color / Material



등판 BACK / 좌판 SEAT

GY(CF101) FABRIC	DG(CF401) FABRIC	BK(CF251) FABRIC	GN(CF251+CF102) FABRIC	VI(CF251+CF103) FABRIC
---------------------	---------------------	---------------------	---------------------------	---------------------------

- 이동시 소음과 바닥 긁힘을 방지하는 테프론 글라이드를 적용하였습니다.
- 좌판 하부의 틸팅 메커니즘을 통해 사용자의 자연스러운 자세를 유지합니다.
- 팔걸이 유무에 관계없이 적용가능한 수직 적층 기능으로 보관과 이동이 편리합니다.

- Teflon glide devices are designed to prevent noise and scratches when you move furniture.
- Tilting mechanisms beneath seat boards make user stance natural.
- Regardless of the existence of armrests, these chairs are designed to stack on top of each other, guaranteeing convenience in both storage and transportation.



팔걸이+캐스터형
Armrest+Ball Caster Type
OH 411
W600 D590 H810



팔걸이+기본형
Armrest+Standard Type
OH 410
W600 D590 H810



캐스터형
Ball Caster Type
OH 401
W550 D590 H810



기본형
Standard Type
OH 400
W550 D590 H810



백틸트
Back Tilt

MULTI-USE

M151G

세미나 룸, 강당, 교실 등에 적합한 세미나 의자. 폴딩 의자로 사용 및 보관이 간편하며 캐스터가 부착되어 이동이 원활한 다목적 의자입니다.

A seminar chair appropriate for seminar rooms, auditoriums, classrooms, and etc. It is a multipurpose folding chair that is easy to use and store. The castors that are attached make them easy to move.



한국산업디자인상
Korea Industrial
Design Awards



굿디자인
GOOD
DESIGN

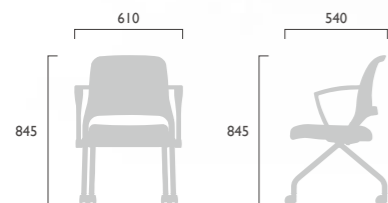

	Color / Material				
등판 BACK					
좌판 SEAT	BLACK FABRIC	BK(CM15101) MESH	GY(CM15102) MESH	BU(CM15104) MESH	GN(CM15105) MESH
	BLACK FABRIC	BLACK FABRIC	BLACK FABRIC	BLACK FABRIC	BLACK FABRIC

- 1 조용하고 부드럽게 이동이 가능한 기능성 볼캐스터를 적용하였습니다.
- 2 좌판 하부의 틸팅 메커니즘을 통해 사용자의 자연스러운 자세를 유지합니다.
- 3 보관과 이동이 간편하고 공간활용이 뛰어난 적층식 구조

- 1 It is equipped with highly practical ball casters for quiet and soft movement.
- 2 Tilting mechanisms beneath seat boards make user stance natural.
- 3 Stacking structure enables easy storage, moving and outstanding space saving.



패드형 PAD TYPE

MOH 15120P
W610 D540 H820-890



MOH 15191P
W610 D540 H845



MOH 15190P
W540 D540 H845



매쉬형 MESH TYPE

MOH 15120M
W610 D540 H820-890



MOH 15191M
W610 D540 H845



MOH 15190M
W540 D540 H845



백틸트
Back Tilt



가스식 높낮이조절
Gas Spray Seat Height
Adjustment

M100G

기존의 라인을 탈피하여 미려한 곡선의 표현으로 두께감을 줄여 슬림한 디자인을 구현하였으며, 단순하고 독특한 구조로 Multi-Use Chair의 새로운 패러다임을 제안합니다.

Implements a slim design by reducing thickness with an elegant curve, breaking from traditional lines and offering a new paradigm in multi-purpose seating with a simple and unique structure.

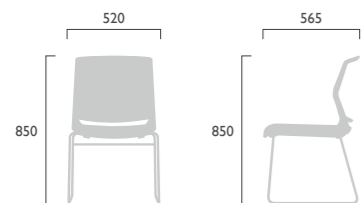

Color / Material			
등판 BACK / 좌판 SEAT			
RE(CM10001) MESH	GN(CM10002) MESH	BU(CM10003) MESH	GY(CM10004) MESH

- 1 수직 적층 기능으로 보관과 이동이 편리합니다.
 - 2 인체공학적인 일체형 등·좌판 구조에 등판은 통기성이 우수한 메쉬를, 좌판은 착석감이 우수한 패딩을 적용하였습니다.
 - 3 펠트 글라이더를 적용하여 바닥면과의 마찰 소음과 긁힘을 최소화 하였습니다.
- 1 These chairs are designed to stack on top of each other, guaranteeing convenience in both storage and transportation.
 - 2 The ergonomic one-piece structure is furnished with a mesh backseat that provides excellent air permeability and a padded seat that deliver outstanding seating comfort to the user.
 - 3 Equipped with felt chair gliders, the risk of friction noise and scratches on the floor are minimized.



MOH 10011
W600 D565 H755-820



MOH 10090
W520 D565 H850



M152G

곡선과 직선이 만드는 미니멀 & 슬림한 디자인은 한층 업그레이드된 분위기를 연출합니다. 이동성과 보관성을 높여 좁은 공간을 효율적으로 활용할 수 있습니다.

Its minimal, slim design characterized by harmonious lines and curves helps create a more sophisticated atmosphere. It also helps maximize the use of space with its outstanding mobility and storage capacity.

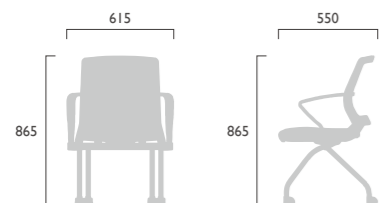

	Color / Material			
등판 BACK	RE(CM1521)	GN(CM1522)	BU(CM1523)	DG(CM1524)
좌판 SEAT	DG(CF1521)	DG(CF1521)	DG(CF1521)	DG(CF1521)
	MESH	MESH	MESH	MESH
	FABRIC	FABRIC	FABRIC	FABRIC

- 좌판을 등판방향으로 접은 후 수평으로 겹쳐져 보관이 용이하여 공간을 효율적으로 사용할 수 있습니다. (네스팅 기능)
- 좌판을 등판방향으로 접을 수 있는 좌판 폴딩기능을 적용하여 의자의 부피를 최소화시킬 수 있습니다.
- 사용자가 몸을 젖힐 때 등판이 틸팅되는 백틸팅을 적용하여 장시간 사용시 발생하는 불편함을 덜어줍니다.

- The seat can be folded vertically, improving its storage capacity and spatial efficiency remarkably (nesting feature).
- Users can minimize the chair's volume by folding the seat towards the backrest.
- It is equipped with a back-tilting feature enabling users to lean backwards and take a rest after long hours of sitting.



캐스터+팔걸이형
Ball Caster+Armrest Type
MOH 15291
W615 D550 H865

캐스터형
Ball Caster Type
MOH 15290
W535 D550 H865

글라이더+팔걸이형
Glider+Armrest Type
MOH 15293
W615 D550 H870

글라이더형
Glider Type
MOH 15292
W535 D550 H870



M153G

회의실, 기숙사, 세미나실 등 어떤 공간에서도 잘 어울리는 M153G. 곡선 형태의 측면디자인과 PIVOT 틸팅기능으로 사용자의 움직임을 보다 자유롭게 해줍니다.

M153G, such as meeting room, dormitory, seminar room which goes well in any space. Curved side design and PIVOT tilting make your movement more flexible.

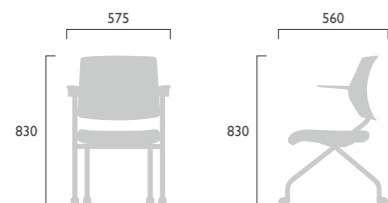

Color / Material	
등판 BACK	RE(CM1521) MESH
좌판 SEAT	DG(CF1521) FABRIC



- 1 좌판을 등판방향으로 접은 후 수평으로 겹쳐서 보관할 수 있어 공간을 효율적으로 사용할 수 있습니다. (네스팅 기능)
- 2 팔걸이가 책상에 부딪힐 경우, 팔걸이를 위로 올리면 책상과 최대한 밀착이 가능합니다.
- 3 사용자가 몸을 젖힐 때 등판이 회전하는 PIVOT 틸팅을 적용하여 장시간 앉아있어도 불편함이 적습니다.

- 1 You can fold the seat in the direction of the backing plate and stack it horizontally, so you can use the space efficiently. (Nesting function)
- 2 If the armrest hits the desk, lift the armrest up to the desk as close as possible.
- 3 PIVOT tilting by rotating the back plate when the user tilts the body makes less discomfort even if you sit for a long time.



팔걸이형
Armrest Type
MOH 15391
W575 D560 H830



백 틸트
Back Tilt

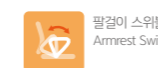

팔걸이 스윙블
Armrest Swivel

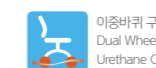

이중바퀴 구조의 우레탄 캐스터
Dual Wheel
Urethane Caster

MULTI-USE



Seminar NEW

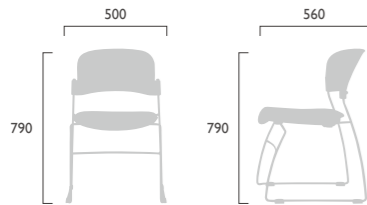

- 1 착석자의 몸무게에 따라 틸팅 강도가 자동으로 셋팅되는 체중 감응형 틸팅을 적용하여 편안한 착석감을 제공합니다.
 - 2 의자를 적층하여 보관할 수 있어 공간 활용이 용이하며 이동형 카트(옵션) 사용시 더 많은 의자를 보관, 이동하기에 편리합니다. (이동형 카트 : 최대 10개 적층 권장)
 - 3 마모방지 기능이 있는 글라이드를 적용하여 손상, 소음 없이 제품을 이동시킬 수 있습니다.
- 1 By applying weight sensitive tilting which automatically set its tilting strength, the comfortable seating can be provided to the user.
 - 2 Chairs can be stacked for easy storage, and more chairs can be stored and convenient to move when using an optional mobile cart. (Mobile cart: recommended stacking up to 10)
 - 3 Glide with anti-wear function can move the product without damage or noise.



H010691 ~ H010694
W500 D560 H790

H010695 ~ H010698
W500 D560 H790

H010996
W500 D560 H790

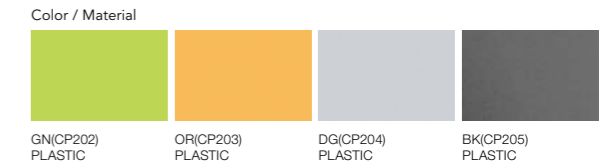

200G

인체 공학적 설계와 부드럽고 세련된 디자인은 어떠한 장소에서도 자유롭고 실용적으로 공간을 연출할 수 있습니다.

Using human - engineering and refined design, 200G allow you to create a multifaceted working space that can be used anywhere such as conference rooms, office, seminar rooms, hospital, school with functional diversity.

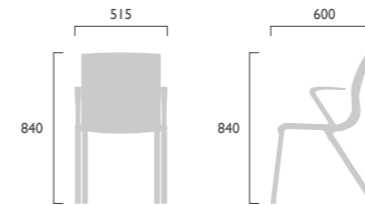

- 1 의자의 일렬 연결시 간단하게 연결할 수 있는 연결 고정클립
 - 2 일체형 플라스틱 등·좌판 SHELL
- 1 Assembly clamps to facilitate the linear connection of chairs
 - 2 One-body plastic seat-backrest



OH 210
W515 D600 H840

OH 200
W515 D600 H840



연결 고정클립
ASSEMBLY CLAMP
OHBRK 200

MULTI-USE

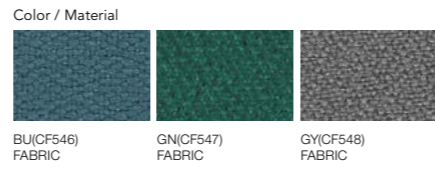

350G



- 1 좌판 쿠션 패드
 - 2 보관과 이동이 간편하고 공간활용이 뛰어난 적층식 구조
 - 3 이동시 소음과 바닥 긁힘을 방지하는 테프론 글라이드.
- 1 It minimizes fatigue by applying low bench cushion pad.
 2 Stacking structure enables easy storage, moving and outstanding space saving.
 3 Teflon glide devices are designed to prevent noise and scratches when you move furniture.



M253G



- 1 팔걸이 유무에 관계없이 수직 적층이 가능하여 보관이 용이하고 이동이 수월합니다.
 - 2 자연스러운 비치 성형합판의 등판과 인락한 성형 스폰지의 좌판으로 구성하였습니다.
- 1 Vertical stacking function is efficient in narrow space.
 2 Consisted with natural plywood back and comfortable sponge seat.



MULTI-USE



정전기 방지
Removal of static electricity

Color / Material



DG(CP102) PLASTIC GN(CP103) PLASTIC VI(CP104) PLASTIC SEAT PAD GY(CF548) FABRIC GN(CF102) FABRIC VI(CF103) FABRIC

100G

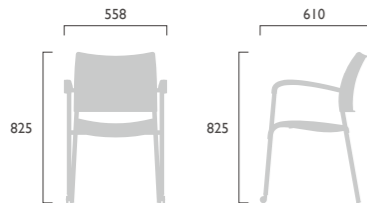

- 1 이동시 소음과 바닥 긁힘을 방지하는 테프론 글라이드
- 2 좌판 쿠션 패드(OH-P)
- 3 고강도의 간결한 조립구조

- 1 Teflon glide devices are designed to prevent noise and scratches when you move furniture.
- 2 It minimizes fatigue by applying low bench cushion pad (OH-P)
- 3 Sturdy structure and simple knock-down assembly for maximum user benefit



팔걸이+캐스터형
Armrest+Ball Caster Type
OH 111P
W558 D610 H825

OH 111
W558 D610 H825

OH 111P : 좌판 패드 (Seat Pad)



팔걸이+기본형
Armrest+Standard Type
OH 110P
W558 D590 H825

OH 110
W558 D590 H825

OH 110P : 좌판 패드 (Seat Pad)



캐스터형
Ball Caster Type
OH 101P
W490 D610 H825

OH 101
W490 D610 H825

OH 101P : 좌판 패드 (Seat Pad)



기본형
Standard Type
OH 100P
W490 D580 H825

OH 100
W490 D580 H825

OH 100P : 좌판 패드 (Seat Pad)

Color / Material



등판 BACK / 좌판 SEAT WH(CP2501) PLASTIC BK(CP2502) PLASTIC

M250G

M250의 일체형 등/좌판 Shell의 모던한 디자인은 다이닝, 홈오피스, 로비 등과 같은 공간에 잘 어울립니다. 또한 등받이의 텐션은 사용자에게 안락감을 더하여 줍니다.

The modern design of the M250's all-in-one back/seat shell fits into the space such dining room, home office and lobby spaces. The tension of the backrest also adds comfort to the user.



- 1 수직방향의 적층기능으로 보관이 용이하며 공간을 효율적으로 활용할 수 있습니다. ※ 적층 시 손이 끼이지 않도록 주의가 반드시 필요하며, 반복적인 적층사용 시 제품에 스크래치가 생길 수 있습니다.
- 2 등판 상단의 손잡이를 사용하면 운반이 용이합니다.
- 3 글라이더를 적용하여 바닥 스크래치를 방지하였습니다.

- 1 Vertical stacking function makes it easy to store and use space efficiently. ※ It is necessary to take care not to get hands in when stacking, and it may scratch the product when repeatedly laminated.
- 2 It is easy to carry by using the handle at the top of the back plate.
- 3 Apply glider to prevent floor scratches.

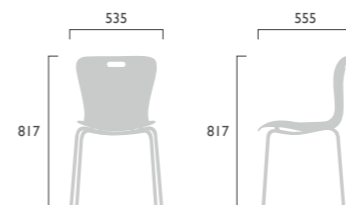

MOH 25090
W535 D555 H817

Color / Material

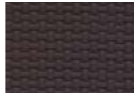

BR(CA501)
ARTIFICIAL LEATHER

Color / Material

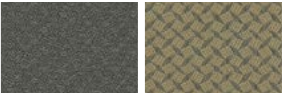

GY(CF231)
FABRIC

BE(CF232)
FABRIC

LH 5000 Group

대형 건물의 로비, 병원이나 은행의 대기실 등에 사용되는 로비 의자.
편안하고 견고하며 간이 테이블까지 부착되어 편리성 또한 뛰어납니다.

A lobby chair used in the lobbies of large building or in the waiting rooms of hospitals or banks. The comfortable and sturdy table that is attached makes it convenient.



굿디자인
GOOD DESIGN



핀업디자인상
PIN UP
Design Awards



호주세계디자인상
Australian International
Design Award

LH 200 Group

현대 감각의 컨템퍼러리 디자인, 편안한 착석감과 여유있는 넓이로 고객에게 좋은 이미지를
심어주는 로비의자의 베스트 셀러 - 콤포시리즈

The Compo series - a best selling lobby chair with a contemporary design that
projects a pleasing image to clients with its comfort and spaciousness.



일반형 Normal

LH5031(3인용 3 Person)
1672 · 694 · 902
LH5041(4인용 4 Person)
2211 · 694 · 902



Color. BR(CA501)

사이드 테이블형 Side Table Type

LH5031S(3인용 3 Person)
2120 · 694 · 902
LH5041S(4인용 4 Person)
2663 · 694 · 902



Color. BR(CA501)

양측 팔걸이형 Armrest Type(Only Side)

LH5032(3인용 3 Person)
1753 · 694 · 902
LH5042(4인용 4 Person)
2293 · 694 · 902



Color. BR(CA501)

**양측 팔걸이+사이드 테이블형
Armrest(Only Side)+Side Table Type**

LH5032S(3인용 3 Person)
2207 · 694 · 902
LH5042S(4인용 4 Person)
2747 · 694 · 902



Color. BR(CA501)

팔걸이형 Armrest Type

LH5033(3인용 3 Person)
1753 · 694 · 902
LH5043(4인용 4 Person)
2293 · 694 · 902



Color. BR(CA501)

**팔걸이+사이드 테이블형
Armrest+Side Table Type**

LH5033S(3인용 3 Person)
2207 · 694 · 902
LH5043S(4인용 4 Person)
2747 · 694 · 902



Color. BR(CA501)

로비의자 Lobby Chair

LH230 1600 · 610 · 410



Color. GY(CF231) / BE(CF232)

로비의자 Lobby Chair

LH230M 1600 · 610 · 410



Color. GY(CF231) / BE(CF232)

로비의자 Lobby Chair

LH230S 1940 · 610 · 410



Color. GY(CF231) / BE(CF232)

로비의자 Lobby Chair

LH231 1600 · 650 · 887



Color. GY(CF231) / BE(CF232)

로비의자 Lobby Chair

LH231M 1600 · 650 · 887



Color. GY(CF231) / BE(CF232)

로비의자 Lobby Chair

LH231S 1970 · 650 · 887



Color. GY(CF231) / BE(CF232)

로비의자 Lobby Chair

LH232 1700 · 650 · 887



Color. GY(CF231) / BE(CF232)

STOOL

Color / Material			
좌판 SEAT			
GN(CF60001) FABIC	GY(CF60002) FABIC	RE(CF60003) FABIC	BU(CF60004) FABIC

CST6000G

공용공간 구성 포인트 스톨, 사무공간 내 보조 의자, 허리가 불편한 분들을 위한 헬스케어 기능성 스톨 의자입니다. 유선형 튜립 형태의 독특한 디자인은 공간 분위기를 효과적으로 연출시킬 수 있습니다.

Public space point stool. Auxiliary chair in office space. CST6000 certified by BIFMA for healthcare effect for people with back problems. It is a health care functional stool chair that transforms the space atmosphere with

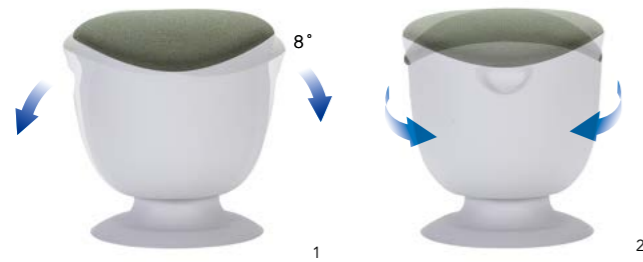

- 1 360도 방향에서 약 8도의 액티브 틸팅 시스템을 적용하여 앉은 상태에서 허벅지와 복부, 등 근육을 고르게 사용하여 허리에 가해지는 압력을 분산시키고 몸의 밸런스를 유지할 수 있습니다.
- 2 내부 중심봉을 이용한 360도 회전 기능을 제공하여 앉은 자세의 불균형으로 인해 뭉쳐있는 하중을 고르게 분산시켜 편안함을 제공합니다.

- 1 With an active tilting system of about 8 degrees from 360 degrees, you can even use your thighs and abdominal muscles evenly in your sitting position to distribute the pressure on your back and balance your body.
- 2 360 degree rotation function using inner center rod provides comfort by evenly distributing the accumulated load due to unbalanced sitting position.

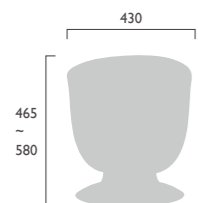

액티브 틸트형
Active Tilt Type
CST6000FT
W430 D410 H465-580



일반형
General Type
CST6000F
W430 D410 H465-580



Color / Material		
좌판 SEAT		
BK(CP2511) PLASTIC	WH(CP2512) PLASTIC	RE(CP2513) PLASTIC

M251G

원형 곡선라인이 감각적인 디자인 스톨로 컴팩트한 사이즈와 가벼운 중량으로 공간에 제약이 적으며 트렌디한 컬러감으로 다양한 오피스 공간에 포인트를 줄 수 있습니다.

Public space point stool. Auxiliary chair in office space. CST6000 certified by BIFMA for healthcare effect for people with back problems. It is a health care functional stool chair that transforms the space atmosphere with.

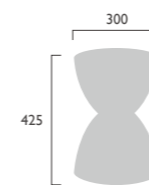

MOH 25190
W300 D300 H425



Office PUBLIC

AMENITY



C600 Group 232 RS2 201 Group 244 RS2 200 Group 246 RS1 100 Group 248

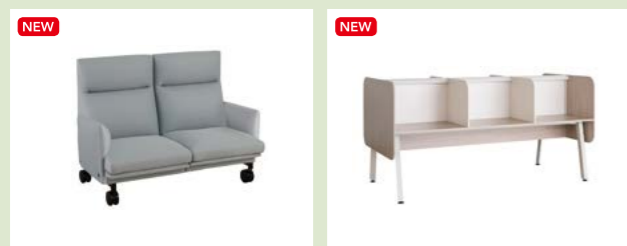

Archive 254 Linkable 256

SOFA



8100 Group 258 800 Group 258 RS7 700 Group 259 RS7 701 Group 259

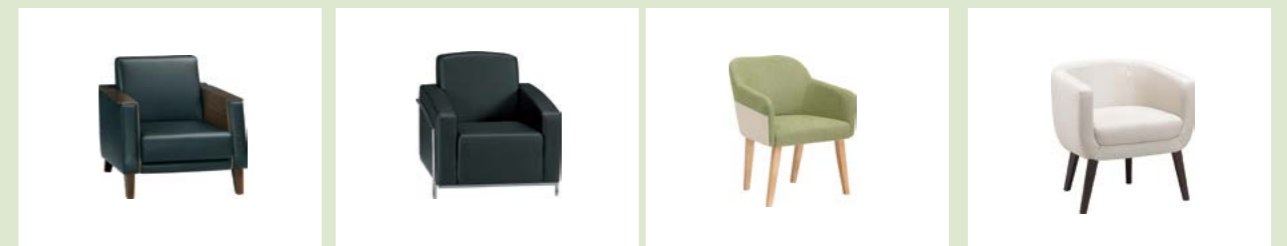

7000 Group 260 3200 Group 260 RS3 300 Group 261 RS5 500 Group 261

SOFA TABLE



HC1 100 Group 262 HC2 200 Group 262 HC3 300 Group 263 C600 Group 263

C600 Group

Combination type common zone of new module

새로운 모듈의 조합형 공용존

구성원들의 업무성과를 높이기 위해 자연스러운 커뮤니케이션이 가능한 환경 조성이 가장 중요합니다. 홈 스타일로 보다 편안한 스마트 오피스를 제공해 드립니다.

Creating an environment, where members can easily communicate with each other to improve the work performance is important. We provide a comfortable smart office created with home style.



모듈소파 CMS60090 팔걸이형소파 CMS50011AL/R 스톨소파 CST60000 티테이블 COT60010R / COT60070R
사각소파테이블 COT60060S 원형소파테이블 COT60060R 사각스탠딩테이블 CST10016S 바스툴 GBS10010HA

C600 Group Collaboration Space

경직된 분위기의 업무 스타일에서 벗어나 편안한 분위기에서 차 한잔을 마시며, 편안한 라운지에서 다양한 지원부서와의 다양한 커뮤니케이션소통을 위한 새로운 스마트 오피스 타입을 추천합니다.

Relax in a relaxed atmosphere, relax in a cozy lounge, we recommend a new smart office type for communication with various support departments in a comfortable lounge by drinking tea in a comfortable atmosphere, away from a strict atmosphere of work style.



모듈소파 CMS60090, CMS60090ST
스툴소파 CST60000 티테이블 COT60010R / COT600X0R

라운지 공간 Lounge Space

업무 공간 내에 라운지를 만들어 동료들과 정보를 손쉽게 공유할 수 있습니다.
You can easily share information with colleagues by creating a lounge in your workspace.



모듈소파 CMS60090 / CMS60090ST 스툴소파 CST60000
사각소파티이블 COT60060S 스토리지 CSE60070 / CSE60090 행잉티이블 COT60016HN

카페 & 휴식 공간 Cafe & Refresh Space

업무에 지쳐 잠시 쉬고 싶을 때 바 테이블에서 여유를 누릴 수 있습니다.
You can relax at the bar table when you want to rest for a while.



사각스탠딩티이블 COT60016S 바스툴 GBS10010HA / CBS60010H

캐주얼한 회의 공간 Instant Meeting Space

작은 미팅 공간으로 간단한 업무 협의를 위한 효율적인 공간으로 활용하실 수 있습니다.
You can use a small meeting space as an efficient space for simple business consultation.



- 1 스토리지는 쿠션을 사용하여 간이 벤치로 사용이 가능하며, 파티션으로 수납과 공간 구획을 동시에 할 수 있습니다. (옵션품목)
- 2 스탠딩테이블은 하부가림판으로 여성분들도 안심하고 앉을 수 있습니다.

- 1 Storage can be used as a simple bench using cushions and can use partitions to divide storage and space. (optional item)
- 2 Standing tables have the bottom cover plate and allow ladies to sit comfortably.

C600 Group Workshop Space

업무 공간과 가까운 공간에서 정식, 비정식 회의가 다양하게 이루어져 즉각적인 커뮤니케이션이 가능합니다.
스탠딩 파티션과 테이블, 소파 등을 활용하여 회의의 성격에 따른 공간으로 구성해보세요.

A variety of formal and informal meetings may be held in a space close to the workspace to enable immediate communication.
Use standing partitions, tables and sofas to organize the space according to the characteristic of the meeting.



이동형 TV 스탠드 CTS6000M 조합형 회의 테이블 CMT10018DRR
바스툴 CBS60010L 이지체어 SFO30030

정식 회의공간 Formal Meeting Space

스탠딩 파티션과 테이블로 앉아서도 서서도 일할 수 있는 회의 공간은 능률을 올려줍니다.

Standing partitions and tables that allow you to sit or stand while working improve work efficiency.



이동형 TV 스탠드 CTS6000M 회의 테이블 CCT60018D 이지체어 SFO30030

디지털 회의 공간 Digital Meeting Space

휴대폰, 노트북으로 시각적인 회의 자료를 활용, 공유하실 수 있습니다.

You can utilize and share visual conference materials on your mobile phone or laptop.



(좌) 조합형 회의테이블 CMT60026DRR 이지체어 SFO30030 낮은바스툴 CBS60010L 이동형 TV 스탠드 CTS6000M
(우) 사각스탠딩테이블 CST60016S 높은바스툴 CBS60010



- 1 이동형 TV 스탠드 전면 리모컨 거치대
- 2 인조가죽소재의 커버 안쪽으로 케이블을 매립하여 깔끔한 배선처리가 가능합니다.
- 3 라운드형 상판은 자유로운 회의 분위기를 조성하며 애쉬 원목 덕트 덮개는 세련된 느낌을 연출해줍니다.

- 1 Movable remote-control holder in the front of TV stand
- 2 Cables can be embedded inside the cover of artificial leather material for neat wiring.
- 3 The round-shaped top plate creates an unconstrained meeting atmosphere, and the wiring duct of the Ash wood gives a sophisticated feeling.

C600 Group Focus Space

스탠딩 파티션, 소파, 조명으로 편안하고 안락한 공간에서 개인 업무 및 회의로 활용합니다.

We create a personal work space and a small meeting room within a comfortable and homey space with higher standing partitions and sofas with disturbance from lighting.



모듈소파 CMS60090 하이백소파 CMS60090H 스펀소파 CST60000
회의테이블 CCT60018 스크린 CSP60070, CSP60090

자유로운 회의 공간 Informal Meeting Space

편안한 분위기에서 회의하실 수 있는 소파로 구성된 미팅룸은 좋은 결과물을 창출해냅니다.

A meeting room with sofas that allow you to have a meeting in a comfortable atmosphere helps you produce great results.



팔걸이형 소파 CMS60011ALL/R 회의테이블 OCT60018D 스크린 CSP60070 / CSP60090

그룹 집중 공간 Group Focus Space

편안한 소파와 파티션으로 그룹회의를 자유롭게 할 수 있습니다.

You can have a group meeting in the meeting rooms made with partitions and comfortable sofas.



- 1 팔걸이에 매립된 조명은 업무의 편의성을 더했습니다. (옵션품목)
- 2 쿠션의 볼륨감과 자작나무 엷지를 믹스한 디자인은 따뜻한 느낌을 줍니다.
- 3 소파 하단부에 멀티탭을 설치하여 전자기기 사용이 편리합니다. (옵션품목)
- 4 유니크한 소파 등받이 라인은 공간 디자인의 스타일을 살려줍니다.

- 1 The light embedded in the armrest adds convenience to work. (Optional item)
- 2 The design that mixes the volume of the cushion and the birch edge gives a warm feeling.
- 3 It is convenient to use electronic equipment because a multi tap is installed at the bottom of the sofa. (Optional item)
- 4 Unique sofa back lines enhance the style of the space design.

C600 Group

공간별 특성에 맞춰 다양한 레이아웃 연출이 가능한 601G, 간결한 디자인으로 인테리어 연출을 도와줍니다.

601G, which can produce various layout according to the characteristics of space in any space. It is very easy to produce a layout that suits the design characteristics with no unnecessary.



개인 집중 공간 Individual Focus Space

주변의 시선이나 소음과 관계없이 개인만의 공간에서 집중해서 일하실 수 있습니다.
You can focus on your personal space regardless of other people's attention or noise.

C600 Group



600G 소파 600G Sofa
CMS60090 900 · 700 · 840

Color. BU / GN / GY / RE



600G 스톨소파 600G Stool Sofa
CMS60090STGY 1100 · 700 · 430

Color. GY



600G 팔걸이소파 600G Armrest Sofa
CMS60011AL(R) 1100 · 700 · 840
CMS60011ALL(R) 1100 · 700 · 840
(조명포함)

Color. BU / GN / GY / RE



600G 하이백 소파 600G High Back Sofa
CMS60090H 900 · 700 · 1140

Color. BU / GN / GY / RE



사각스툴 Stool
CST60000 420 · 420 · 420

Color. BU / GN / GY / RE



하이바스툴 High Bar Stool
CBS60010H 350 · 385 · 762

Color. BU / GN / GY / RE



로우바스툴 Low Bar Stool
CBS60010L 350 · 385 · 622

Color. BU / GN / GY / RE



사각회의테이블 Square Shape Table
 기본형 Standard Type CCT60018
 1800 · 1000 · 730
 덕트형 Duct Type CCT60018D
 1800 · 1000 · 730

Color. SW



타원회의테이블 Ellipse Shape Table
 CCT60018R 1800 · 1000 · 730

Color. SW



조합형회의테이블 Combined Shape Table
 사각+원형 Square+Circle
 CMT60026DRR 2620 · 1000 · 730
 타원+원형 Ellipse+Circle
 CMT60026DSR 2620 · 1000 · 730

Color. SW



스탠딩테이블 Standing Table
 CST60016S 1600 · 900 · 1050

Color. SW / EL



원형 스탠딩 테이블 Round Standing Table
 CST60010R 1200 · 840

Color. SW



단식 바테이블 Single-Sided Standing Table
 H004436 1600 · 450 · 1050

Color. SW



스탠딩파티션 W700
 Standing Partitions W700
 CSP60070 700 · 1500 · 26

Color. GY



스탠딩파티션 W900
 Standing Partitions W900
 CSP60090 900 · 1500 · 26

Color. GY



스탠딩파티션 W1100
 Standing Partitions W1100
 CSP60011 1100 · 1500 · 26

Color. GY



안정각 Stability Angle
 엔드 안정각 End Stability Angle
 CSP600SAE
 중앙 안정각 Center Stability Angle
 CSP600SAC

Color. GY



스토리지 W700 Storage W700
 쿠션+스크린결합형
 Combined with Cushion & Partition
 CSB60070BHC 700 · 350 · 1200

Color. SW



스토리지 W900 Storage W900
 쿠션+스크린결합형
 Combined with Cushion & Partition
 CSB60090BHC 900 · 350 · 1200

Color. SW



스토리지 W700 Storage W700
 스크린결합형 Combined with Partition
 CSB60070BH 700 · 350 · 1200

Color. SW



스토리지 W900 Storage W900
 스크린결합형 Combined with Partition
 CSB60090BH 900 · 350 · 1200

Color. SW

스토리지 W700 Storage W700
 CSB60070B 700 · 350 · 550

Color. SW



스토리지 W900 Storage W900
 CSB60090B 900 · 350 · 550

Color. SW



스토리지 W700 Storage W700
 스토리지 쿠션 Cushion for Storage
 CSB60070CS 700 · 350

Color. BU / GY



스토리지 W900 Storage W900
 스토리지 쿠션 Cushion for Storage
 CSB60090CS 900 · 350

Color. BU / GY



행잉테이블 Hanging Table
 CCT60016HN 1600 · 790 · 730

Color. SW



TV스탠드 TV Stand
 CTS6000M 804 · 604 · 1346

Color. SW



이동형 스탠딩테이블
 Movable Standing Table
 H011000 800 · 600 · 950

Color. OA

Community 601 Group



601G 소파 601G Sofa
 CMS60190 900 · 700 · 840

Color. BU / GN / GY / RE



601G 팔걸이소파 601G Armrest Sofa
 CAR60120LT 200 · 700 · 840

Color. BU / GN / GY / RE



601G 스톨소파 601G Stool Sofa
 CMS60190ST 1100 · 700 · 430

Color. BU / GN / GY / RE

RS2 201 Group

Infuse energy into space with unique designs.

유니크한 디자인으로 공간에 에너지를 불어넣다.

휴식공간, 회의공간으로 사용 가능한 소파구성으로 여러 가지 벤치 조합으로 다양한 공용공간을 연출할 수 있습니다. 직선을 기본으로 한 미니멀한 디자인과 따스한 색감은 공간을 부드럽게 바꿔드립니다.

A sofa configuration that can be used as a resting space or a meeting space allows you to create various public spaces with various bench combinations. A minimal design based on straight lines and warm colors will change the space soft.



벤치소파 SFO20120R / SFO20110CST / SFO20116ST 1인소파 SAO30040 소파테이블 COT20016



- 1 등받이 벤치로 회의 및 업무 시 더욱 편안한 자세로 이용 가능합니다.
- 2 바닥이 고르지 않은 장소에서 레벨러를 돌려 손쉽게 수평을 맞출 수 있습니다.
- 3 벤치, 등받이 벤치, 삼각벤치의 조합으로 다양한 공용 공간 구성이 가능합니다.



- 1 Backrest bench allows for a more comfortable posture for meetings and work.
- 2 You can easily adjust horizontality by turning the leveler in uneven areas.
- 3 A combination of a bench, a backrest bench and a triangular bench allows for a variety of common space configurations.

RS2 201 Group

Color / Material
WG(SF2011)
FABRIC



RS2 200 Group

Design with privacy and communication in mind

프라이버시와 커뮤니케이션을 배려한 디자인

일반 소파와 파티션 스크린을 조합하여 개방형 공간과 독립된 공간 분할이 가능합니다.
트렌디한 컬러의 패브릭의 조합으로 공간을 한층 쾌적하게 만들어 드립니다.

It can be divided into open space and independent space by combining general sofa and partition screen. We make space more comfortable with combination of fabric of trendy color.











높은 등받이소파 SFO20012H(L/R) / SFO20012H 1인소파 SAO30030
스토리지 SFB20007E 4발소파 SFO30030 스툴 MOH25190 소파테이블 COT20016 / COT20006RH



- 1 각종 서적류 수납은 물론이며 콘센트와 무선충전까지 가능한 멀티 스토리지입니다.
- 2 시선을 자연스럽게 차단하여 공용공간의 구획을 효과적으로 구성할 수 있게 해줍니다.
- 3 날렵한 스틸 다릿발을 사용하여 시각적으로 공간을 넓어 보이게 해주며 소파 옆에서 사용 시에도 불편함이 없습니다.

- 1 The multi-storage having function of storing various books, outlets and wireless charging.
- 2 It can block the sight in a natural way, which makes it possible to construct the compartment of public space effectively.
- 3 It uses a slim steel bar to enlarge the space visually and there is no inconvenience when you use it next to the sofa.

RS2 200 Group

		Color / Material			
		BU(SF2003) FABRIC	CH(SF2004) FABRIC	BUC(SF2001) FABRIC	CHC(SF2002) FABRIC
	낮은 등받이형 Low Back Type SFO20011 1100 · 630 · 680		낮은 등받이형 Low Back Type SFO20007 700 · 630 · 680		
Color. BU / CH		Color. BU / CH			
	스툴 Stool SFO20011ST 1100 · 630 · 400		스툴 Stool SFO20007ST 700 · 630 · 400		
Color. BU / CH		Color. BU / CH			
	높은 등받이형 High Back Type SFO20012H 1180 · 670 · 1150		높은 등받이 L형 High Back L-type SFO20012HL 1140 · 670 · 1150		
Color. Screen(BUC/CHC), Sofa(BU/CH)		Color. Screen(BUC/CHC), Sofa(BU/CH)			
	높은 등받이 R형 High Back R-type SFO20012HR 1140 · 670 · 1150		스토리지 Storage SFB20007E 700 · 630 · 400 무선충전기 포함 Include wireless charger		
Color. Screen(BUC/CHC), Sofa(BU/CH)		Color. BU / CH			

RS1 100 Group

Fill the space with unique designs

유니크한 디자인으로 공간을 채우다

산뜻하고 화사한 파스텔 톤, 미니멀리즘의 심플한 디자인으로 탄생되어
공간의 분위기를 몰라보게 변화시키는 모듈 시스템 소파.
인체공학적 설계로 안락감 또한 뛰어난 시스템 소파입니다.
The fresh bright pastel tones and minimalistic simple design of the
module system sofa will completely change the atmosphere
of the room. Its ergonomic design makes it very comfortable.



RS1 100 Group

뛰어난 패션 감각을 느낄 수 있는 다채로운 컬러로 공간의 분위기가 몰라보게 달라집니다. 모듈형으로 제작되어 공간의 크기와 구조에 구애 받지 않고 원하는 대로 자유로이 조합, 설치할 수 있습니다.

Fabrics come in diverse lively and stylish colors. You can install or combine the module into any space or structure you desire.



2530×3290

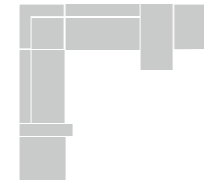

2400×4800



2360×2360

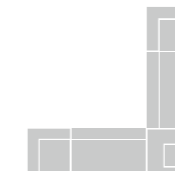

2400×2400



2360×4090

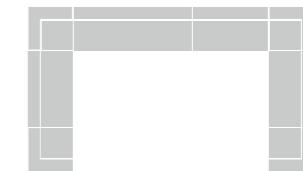

3460×3460

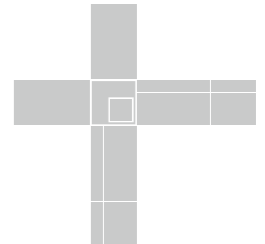

1 소파 사이에 사이드 테이블을 배치하여 잡지 등을 보관할 수 있으며, 고객의 소지품도 편리하게 비치할 수 있습니다.

2 로비나 대기실 등에서 소파와 함께 고객의 편의를 위해 설치되는 잡지꽂이. 2단으로 구성되어 있으며 중간에 콘센트가 부착되어 있습니다.

3 소파 사이에 설치되는 잡지꽂이함.

4 컵, 소지품 등 간단한 소품을 놓을 수 있는 간이 테이블. 콘센트가 달려있어 노트북이나 태블릿, 휴대폰의 충전이 가능합니다.

1 Tables can be placed between sectional pieces for displaying magazines, plants or other items.

2 A magazine stand that can be installed in the lobby or waiting room. It consists of two levels and a socket is attached in the middle.

3 A magazine stand install next to a sofa.

4 A portable table where you can place cups, personal belongings, and other items. A socket is attached, allowing people to recharge laptops and smartphones.

Color / Material		좌판 Seat			등판 Back		좌판 Seat			등판 Back
	LG(SF504) FABRIC		GN(SF506) FABRIC	RE(SF508) FABRIC		IV(SA707) ARTIFICIAL LEATHER		GN(SA705) ARTIFICIAL LEATHER	RE(SA1001) ARTIFICIAL LEATHER	



**등받이형 Back Type
코너형 Corner**
SFO10011(패브릭 Fabric)
630 · 630 · 680
SAO10011(인조가죽 Artificial Leather)
630 · 630 · 680

Color: Fabric(LG+GN / LG+RE)
Artificial Leather(IV+GN / IV+RE)



**등받이형 Back Type
내원형 Endarch**
SFO10021(패브릭 Fabric)
1200 · 1200 · 680
SAO10021(인조가죽 Artificial Leather)
1200 · 1200 · 680

Color: Fabric(LG+GN / LG+RE)
Artificial Leather(IV+GN / IV+RE)



**등받이형 Back Type
외원형 Exdarch**
SFO10021U(패브릭 Fabric)
1200 · 1200 · 680
SAO10021U(인조가죽 Artificial Leather)
1200 · 1200 · 680

Color: Fabric(LG+GN / LG+RE)
Artificial Leather(IV+GN / IV+RE)



**스툴 Stool
코너형 Corner**
SFO10012ST(패브릭 Fabric)
630 · 630 · 400
SAO10012ST(인조가죽 Artificial Leather)
630 · 630 · 400

Color: Fabric(LG / GN / RE)
Artificial Leather(IV / GN / RE)



**스툴 Stool
반원형 Semicircle**
SFO10022ST(패브릭 Fabric)
1260 · 630 · 400
SAO10022ST(인조가죽 Artificial Leather)
1260 · 630 · 400

Color: Fabric(LG / GN / RE)
Artificial Leather(IV / GN / RE)



1인용 스툴 1 Person Stool
SFO10011ST(패브릭 Fabric)
630 · 630 · 400
SAO10011ST(인조가죽 Artificial Leather)
630 · 630 · 400

Color: Fabric(LG / GN / RE)
Artificial Leather(IV / GN / RE)



2인용 스툴 2 Person Stool
SFO10021ST(패브릭 Fabric)
1100 · 630 · 400
SAO10021ST(인조가죽 Artificial Leather)
1100 · 630 · 400

Color: Fabric(LG / GN / RE)
Artificial Leather(IV / GN / RE)



1인용 1 Person
SFO10011(패브릭 Fabric)
630 · 630 · 680
SAO10011(인조가죽 Artificial Leather)
630 · 630 · 680

Color: Fabric(LG+GN / LG+RE)
Artificial Leather(IV+GN / IV+RE)



2인용 2 Person
SFO10021(패브릭 Fabric)
1100 · 630 · 680
SAO10021(인조가죽 Artificial Leather)
1100 · 630 · 680

Color: Fabric(LG+GN / LG+RE)
Artificial Leather(IV+GN / IV+RE)



코너형 Corner Type
SFO10011C(패브릭 Fabric)
630 · 630 · 680
SAO10011C(인조가죽 Artificial Leather)
630 · 630 · 680

Color: Fabric(LG+GN / LG+RE)
Artificial Leather(IV+GN / IV+RE)



파티션 Partition
SPT10007 750 · 170 · 800
SPT10007A 750 · 170 · 800
SPT10011(L/R) 1100 · 170 · 800
SPT10011A(L/R) 1100 · 170 · 800

Color: Fabric(LG/GN)
Artificial Leather(IV/GN)



**파티션간 연결 브라켓
A Partition Connecting Bracket**
SHW10000(1EA) 100 · 60 · 8

Color / Material					
	SW+NO (L1001+L3021) LPM	SW(L1001) LPM	NO(L3021) LPM	LB(SF509) FABRIC	BR(SA7011) ARTIFICIAL LEATHER



낮은 테이블 Low Table
COT10008L 750 · 750 · 450
COT10006L 550 · 550 · 450

COT10008L

Color: SW(L1001)



높은 테이블 High Table
COT10008H 750 · 750 · 660
COT10006H 550 · 550 · 660

10006H

Color: SW(L1001)



사이드 테이블 Side Table
CSB10005 470 · 630 · 390

Color: SW(L1001) / NO(L3021)



스토리지 Storage
CSB10012 1200 · 350 · 680

Color: SW+NO(L1001+L3021)



스토리지 A Storage A
SAB10006D 630 · 630 · 400

Color: LB / BR



스토리지 B Storage B
SAB10006E 630 · 630 · 400

Color: LB / BR



스토리지 C Storage C
SAB10005FT 470 · 930 · 670

Color: LB / BR

Modular working Sofa for Creative Office

크리에이티브 오피스를 위한 모듈형 워크 소파

작은 여유공간부터 넓은 로비공간까지 맞춤형 구성이 가능한 모듈소파로 다양한 업무 레이아웃이 가능한 새로운 워크라운지입니다.

This is a new work lounge optimized for a wide range of work styles, from a small free space to a large lobby space in the office.



소파 H011075 소파테이블 콤보 H011105 / H010890 테이블 H010894 / H011112

확장이 가능한 모듈 구조

팔걸이, 사이드테이블, 연결다릿발(옵션)을 이용해 확장이 가능한 모듈구조입니다. 결합 방식을 통해 4인 이상의 제품 연출이 가능합니다.

* 예시 : 4인(2인+2인), 5인(2인+3인), 6인(3인+3인)

Scalable modular structure

Modular structure that can be extended using armrests, side tables and connecting feet (optional).

The combination method allows the production of products for four or more people.

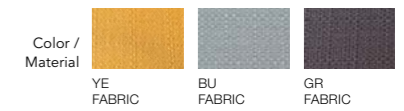
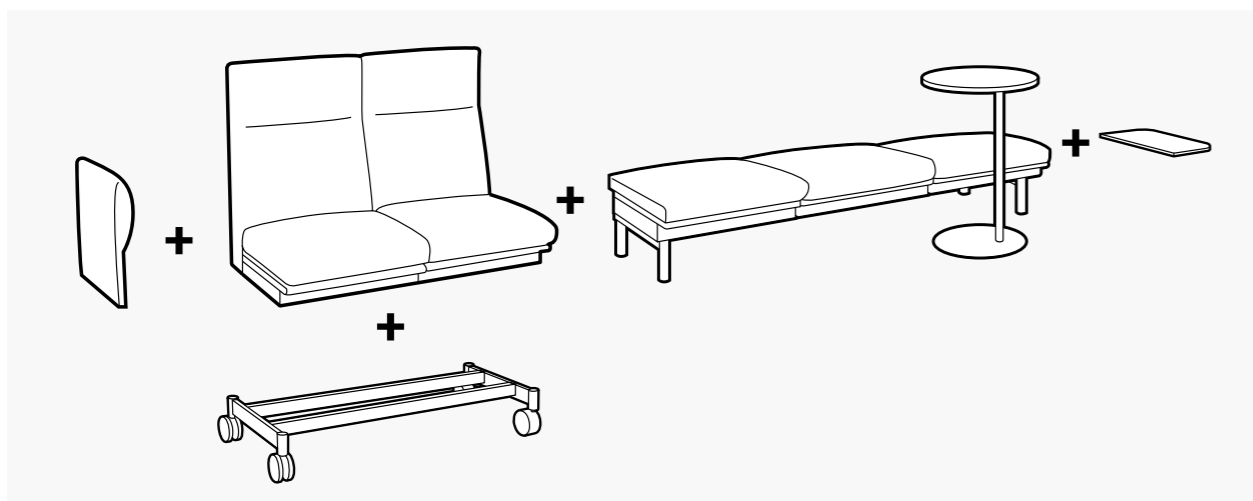

	미들백 1인 Middle Back Type (for 1 Person) H011040 ~ 42 630 · 690 · 765 Color: YE / BU / GR		미들백 2인 Middle Back Type (for 2 Persons) H011043 ~ 45 1260 · 690 · 765 Color: YE / BU / GR
	미들백 3인 Middle Back Type (for 3 Persons) H011046 ~ 48 1890 · 690 · 765 Color: YE / BU / GR		미들백 4인 Middle Back Type (for 4 Persons) H011049 ~ 51 2520 · 690 · 765 Color: YE / BU / GR
	하이백 1인 High Back Type (for 1 Person) H011052 ~ 54 630 · 690 · 1015 Color: YE / BU / GR		하이백 2인 High Back Type (for 2 Persons) H011055 ~ 57 1260 · 690 · 1015 Color: YE / BU / GR
	하이백 3인 High Back Type (for 3 Persons) H011058 ~ 60 1890 · 690 · 1015 Color: YE / BU / GR		하이백 4인 High Back Type (for 4 Persons) H011061 ~ 63 2520 · 690 · 1015 Color: YE / BU / GR
	벤치형 3인 Bench Type (for 3 Persons) H011091 ~ 93 1890 · 690 · 420 Color: YE / BU / GR		콘센트테이블 벤치형 3인 Bench Type (for 3 Persons, Electrical Outlet Included) H011094 ~ 96(상판 BK) 1890 · 690 · 420 H011097 ~ 99(상판 SW) 1890 · 690 · 420 Color: YE / BU / GR
	미들백 1인(팔걸이, 이동형) Movable Middle Back Type (for 1 Person, Armrest Included) H011067 ~ 69 710 · 690 · 765 Color: YE / BU / GR		미들백 2인(팔걸이, 이동형) Movable Middle Back Type (for 2 Persons, Armrest Included) H011070 ~ 72 1340 · 690 · 765 Color: YE / BU / GR
	하이백 1인(팔걸이, 이동형) Movable High Back Type (for 1 Person, Armrest Included) H011073 ~ 75 710 · 690 · 1015 Color: YE / BU / GR		하이백 2인 (팔걸이, 이동형) Movable High Back Type (for 2 Persons, Armrest Included) H011076 ~ 78 1340 · 690 · 1015 Color: YE / BU / GR
	미들백 4인 콘센트 테이블 콤보 Middle Back Type (for 4 Persons, Electrical Outlet Included) H011100 ~ 02(상판 BK) 2780 · 690 · 1015 H011106 ~ 08(상판 SW) 2780 · 690 · 1015 Color: YE / BU / GR		하이백 4인 콘센트 테이블 콤보 High Back Type (for 4 Persons, Electrical Outlet Included) H011103 ~ 05(상판 BK) 2780 · 690 · 1015 H011109 ~ 11(상판 SW) 2780 · 690 · 1015 Color: YE / BU / GR
	봉재팔걸이 Fabric Armrest H010881 ~ 83(L형 L Type) 100 · 620 · 400 H010884 ~ 86(R형 R Type) 100 · 620 · 400 Color: YE / BU / GR		사이드테이블 Side Table H010890 ~ 91(L형 L Type) 230 · 660 · 186 H010892 ~ 93(R형 R Type) 230 · 660 · 186 Color: SW / BK
	세트테이블 Set Table H010894 500 · 500 · 660 Color: OA / SW		바테이블(이동형) Movable Standing Table H011112 1200 · 400 · 900 H011861 1200 · 400 · 900 Color: OA / SW

Linkable NEW

Multistyle table for various offices

다양한 오피스를 위한 멀티스타일 테이블

열람대, 회의테이블, 공용존 테이블 등 여러 용도로 사용이 가능해 실용성이 뛰어납니다. 오피스의 다양한 공간의 변화에 따른 다용도 테이블입니다.

It can be used for various purposes such as reading table, conference table, common zone table, etc., so it is very practical. This is a multipurpose table that changes according to the various spaces in the office.



테이블 H004881 의자 MOH15290

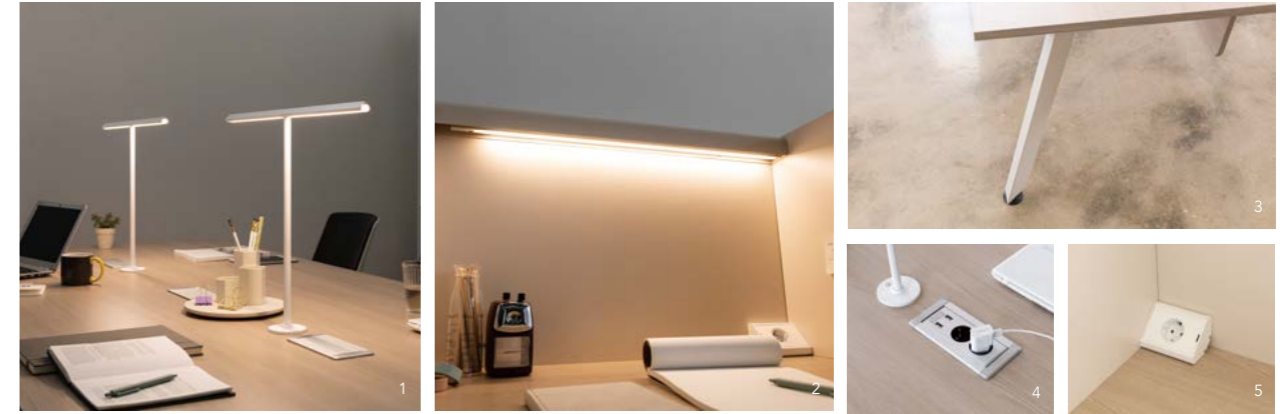

- 1 터치식 스위치를 사용하여 3단계로 밝기 조절이 가능합니다.
- 2 좌석별 센서식 스위치를 사용하여 3단계로 밝기 조절이 가능합니다
- 3 사선으로 떨어지는 라인감으로 날렵한 느낌을 더했습니다.
- 4 회전식으로 사용하는 멀티탭으로 사용하기 편합니다.
- 5 칸막이 테이블은 좌석별로 멀티탭이 제공됩니다.

- 1 The brightness can be adjusted in 3 levels using the touch switch.
- 2 You can adjust the brightness in three stages using the sensor switch for each seat.
- 3 It adds a sleek feeling to the line that falls in diagonal lines.
- 4 Easy to use as a multi-tap for rotary use.
- 5 The partition table has a multi-tap for each seat.

Linkable

		Color / Material	
		LO LPM	IV LPM
	6인 오픈형테이블(조명형) Open type Table for 6 Persons (Light included) H004881 2400 · 1200 · 730		6인 오픈형테이블 Open type Table for 6 Persons H004882 2400 · 1200 · 730
Color. LO / IV		Color. LO / IV	
	4인 오픈형테이블(조명형) Open type Table for 4 Persons (Light included) H004883 1600 · 1200 · 730		4인 오픈형테이블 Individual type Table for 4 Persons H004884 1600 · 1200 · 730
Color. LO / IV		Color. LO / IV	
	6인 칸막이테이블 Individual type Table for 6 Persons H004885 2400 · 1200 · 730		4인 칸막이테이블 Individual Type table for 4 persons H004886 1600 · 1200 · 730
Color. LO / IV		Color. LO / IV	
	조명 Table light H004862(6인용 for 6 Persons) 600 · 460 · 26 H004864(4인용 for 4 Persons) 600 · 460 · 26		콘센트 Socket 칸막이형 for Individual Type Table H004874 회전형 Swing Type H004863
*플레이트 제외 Color. LO / IV			

8100 Group

Color / Material
 SG801 GENUINE LEATHER
 SA801 ARTIFICIAL LEATHER



1인 1 Person
 OS8110(천연가죽 Genuine Leather) 900 · 810 · 850
 OS8112(인조가죽 Artificial Leather) 900 · 810 · 850

Color. SG801 / SA801



3인 3 Person
 OS8130(천연가죽 Genuine Leather) 1980 · 810 · 850
 OS8132(인조가죽 Artificial Leather) 1980 · 810 · 850

Color. SG801 / SA801

* 중역8100G과 매칭 * Match with Executive 8100G

RS7 700 Group

Color / Material
 BR(SG7001) GENUINE LEATHER
 BR(SA7011) ARTIFICIAL LEATHER



1인 1 Person
 SLO70010(천연가죽 Genuine Leather) 900 · 760 · 680
 SAO70010(인조가죽 Artificial Leather) 900 · 760 · 680

Color. BR(SG7001) / BR(SA7011)



2인 2 Person
 SLO70030(천연가죽 Genuine Leather) 1800 · 760 · 680
 SAO70030(인조가죽 Artificial Leather) 1800 · 760 · 680

Color. BR(SG7001) / BR(SA7011)

* 중역EX7 700G과 매칭 * Match with Executive EX7 700G

800 Group

Color / Material
 SG801 GENUINE LEATHER
 SA801 ARTIFICIAL LEATHER



1인 1 Person
 VOS80010G(천연가죽 Genuine Leather) 900 · 810 · 850
 VOS80010A(인조가죽 Artificial Leather) 900 · 810 · 850

Color. SG801 / SA801



3인 3 Person
 VOS80030G(천연가죽 Genuine Leather) 1980 · 810 · 850
 VOS80030A(인조가죽 Artificial Leather) 1980 · 810 · 850

Color. SG801 / SA801

* 중역800G과 매칭 * Match with Executive 800G

RS7 701 Group

Color / Material
 BR(SA7011) ARTIFICIAL LEATHER
 IV(SA707) ARTIFICIAL LEATHER



1인 1 Person
 SAO70110 780 · 760 · 580

Color. BR(SA7011) / IV(SA707)



2인 2 Person
 SAO70120 1380 · 760 · 580

Color. BR(SA7011) / IV(SA707)

* 중역EX3 301G과 매칭 * Match with Executive EX3 301G

7000 Group

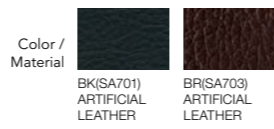

1인 1 Person
OS7012W 800 · 820 · 760

Color. BK(SA701) / BR(SA703)



3인 3 Person
OS7032W 1920 · 820 · 760

Color. BK(SA701) / BR(SA703)

* 중역8100G과 매칭 * Match with Executive 8100G

RS3 300 Group



1인 1 Person
SFO30010(패브릭 Fabric)
610 · 630 · 780

Color. GN(SF502) / IV(SF501)



1인 1 Person
SAO30010(인조가죽 Artificial Leather)
610 · 630 · 780

Color. BR(SA7011) / IV(SA707)



1인 1 Person
SFO30020(패브릭 Fabric)
610 · 630 · 740-825

Color. GN(SF502) / IV(SF501)



1인 1 Person
SAO30020(인조가죽 Artificial Leather)
610 · 630 · 740-825

Color. BR(SA7011) / IV(SA707)



1인 1 Person
SFO30030(패브릭 Fabric)
550 · 535 · 710-770

Color. OR(SF303)



1인 1 Person
SAO30040 700 · 718 · 855
SFO30040 700 · 718 · 855

Color. GY(SF2011), GY(SA2011)

3200 Group

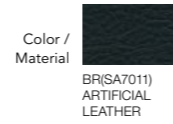

1인 1 Person
OS3212 850 · 830 · 850

Color. SA801



3인 3 Person
OS3232 1830 · 830 · 850

Color. SA801

RS5 500 Group



1인 1 Person
SFO50010(패브릭 Fabric)
640 · 580 · 670

Color. IV(SF501) / GN(SF502)



1인 1 Person
SAO50010(인조가죽 Artificial Leather)
640 · 580 · 670

Color. BK(SA501) / GN(SA705) / YE(SA706) / OR(SA5002)

Sofa Table

다양한 컬러와 소재로 개성을 달리한 소파테이블은 여러 공간에 폭넓게 활용할 수 있습니다.
The sofa table with various colors and materials can be applied to multiple spaces.

HC1 100 Group

Color / Material	Color / Material	Color / Material	Color / Material	Color / Material
SW+NO (L1001+L3021) LPM	SW(L1001) LPM	NO(L3021) LPM	LB(SF509) FABRIC	BR(SA7011) ARTIFICIAL LEATHER



낮은 테이블 Low Table
COT10008L 750 · 750 · 450
COT10006L 550 · 550 · 450

COT10008L

Color. SW(L1001)



높은 테이블 High Table
COT10008H 750 · 750 · 660
COT10006H 550 · 550 · 660

10006H

Color. SW(L1001)

HC2 200 Group

Color / Material
SW(L701) LPM



낮은 테이블 Low Table
COT20016 1600 · 500 · 368
COT20006R 600 · 600 · 368

Color. SW



높은 테이블 High Table
COT20006RH 600 · 600 · 650

Color. SW

HC3 300 Group

Color / Material
EL(L702) LPM



탁자 Table
CCT30006RG 620 · 620 · 450



탁자 Table
CCT30004L 350 · 475 · 450

Color. EL



탁자 Table
CCT30004H 350 · 475 · 660

Color. EL

C600 Group

Color / Material	Color / Material
OA(L501) LPM	SW(L1001) LPM



**원형 소파테이블
Round Sofa Table**
COT60060RSW 700 · 700 · 680

Color. SW



**사각 소파테이블
Square Sofa Table**
COT60060SSW 550 · 550 · 680

Color. SW



**직사각 소파테이블
Rectangle Sofa Table**
COT60070SSW 750 · 550 · 680

Color. SW



**티테이블(대)
Tea Table Large**
COT60010ROA 1030 · 770 · 353

Color. OA



**티테이블(소)
Tea Table Small**
COT60070ROA 600 · 619 · 423

Color. OA

Dormitory

New-concept dorm furniture

신개념 기숙사 가구

책상과 수납장, 침대가 조합되어 편리하게 사용할 수 있는 신개념 기숙사 가구. 수직 공간을 충분히 활용하여 좁은 공간을 넓게 사용할 수 있습니다. New-concept dorm furniture with a desk, a cabinet and a bed all rolled into one for space efficiency and convenience.



책상 DSD3012 침대 DBE3021A 옷장 DOW3060L



Dormitory System Bed (15 Floors)

공간을 효과적으로 활용할 수 있도록 침대, 책상, 수납장으로 구성된 시스템가구.

The system furniture consisting of the bed, desk and storage to make effective use of the space.

Dormitory Bed

공간의 효율을 극대화 시켜주는 1인, 2인 침대. Single beds and double beds that optimize the space efficiency.



- 1 프레임에 가리고, 각종 소품을 편리하게 보관할 수 있는 난간덮개.(옵션품목, DCF3000GN)
- 2 하부 책상은 전·후면에 수납공간으로 설계하였으며, 다목적 옷장과 수납장에 볼캐스터를 적용하여 침대 뒷공간을 개인 창고로 활용할 수 있습니다.
- 3 트렁크 등의 박스형 물품 보관이 용이한 높은 1인용 침대의 하부 수납공간.
- 4 2층 침대의 사다리 사용을 대신하여 수납공간 확장이 가능한 계단형 수납장.

- 1 Rail cover (optional) that covers the frame and conveniently stores various small items.
- 2 Shelves in the lower section are designed as storage space in the front and back. With application of ball caster to the storage and multi-purpose wardrobe, the back space of the bed can be utilized as a personal warehouse.
- 3 Lower storage space in the lofty single bed for easy storage of box type items, such as trunks.
- 4 Desk type shelf which enables to expand storage space instead of using ladder in two-floors bed.

Dormitory Desk

공간의 효율을 극대화하는 책상 유닛.

The desk unit that can optimize space efficiency.



- 1 책장형 책상: 책상에 부착된 조명등으로 학습 집중도를 높여 드립니다.
 - 2 책장형 책상: 책상 배선을 위해 설계되어 개폐가 편리한 4구 콘센트와 배선홀 책상에 설계된 알루미늄 액세서리 바.(액세서리: 옵션품목)
 - 3 조합형 책상: 캐스터가 적용된 책상은 자유롭게 이동이 가능하고 재배치가 용이합니다.
 - 4 패딩이 부착된 서랍박스는 수납 뿐만아니라 보조의자로도 활용이 가능합니다.
- 1 Lighting on the desk enhances concentration and studying efficiency.
 - 2 Easy to open a four port electric socket and wiring groove hole designed for desk wiring. Aluminum accessory bar on the desk (accessories: optional).
 - 3 Desk which has a combination desk/caster can be moved freely and is very convenient for rearrangement.
 - 4 Drawer box with DDB1004/padding can store and also use it as an auxiliary seat.

Dormitory Wardrobe & etc.

공간의 크기와 용도에 맞게 다양한 선택이 가능한 옷장.

The wardrobe suitable for various space size and use of space.



- 1 다양한 구성과 사이즈의 옷장 품목으로 어떤 공간에도 알맞게 적용이 가능합니다.
 - 2 옷장 내부는 1인용과 2인용이 같은 구조이며, 선반/행거/2단 스틸 바스켓으로 구성됩니다.
 - 3 신발장 내부는 트레이, 우산꽂이와 물받침, 슬라이드 사출서랍이 있어 다양한 집기들을 정돈할 수 있습니다.
- 1 It can be applied to any space by wardrobes with various types and sizes.
 - 2 Wardrobe interior is the same for both one-person size and two-person size; comprising shelves, hangers, and two-story steel baskets.
 - 3 The shoe closet can accommodate various stuff with its trays, umbrella stands and slide drawers.



Library

The ubiquitous library where information literacy and exchange are possible



정보의 활용과 교류가 가능한 유니쿼터스 도서관

활발한 정보 교류와 활용이 가능한 유니쿼터스 도서관으로의 변화를 주도하는 도서관 가구로서 도서관의 새로운 기준을 제시합니다.

It offers the new standard of the library as the library furniture that leads change to the ubiquitous library where information literacy and exchange are possible.



- 1 북엔드
 - 2 북 디스플레이: 원하는 선반으로 다양한 조합 구성이 가능하고, 선반 높이를 쉽게 조절할 수 있습니다.
 - 3 브라켓
 - 4 싸인걸이 커넥터
- 1 Book End
 - 2 Book display: It is able to create various combinations into a shelf that user wants to look like, along with being able to control height of shelf easily.
 - 3 Bracket
 - 4 Sign hanger connector

Healthcare

Neo+Medics, Special Hospital Furniture by Neoce

네오스 병원전문가구 Neo+Medics

인간의 건강한 삶을 중시하고 쾌적한 자연 환경을 고려하며
안전하고 미래지향적인 병원을 꿈꿉니다.

Dream of a safe and future-oriented hospital that features a pleasant
natural environment and is focused on your health.



- 1 효율적인 공간 활용을 위한 냉장고 삽입형 상드대와 실크 스크린을 적용한 플라워 패턴 도어.(옵션)
- 2 전기구의 편리한 사용을 위해 데드 스페이스에 설계된 콘센트 유닛.
- 3 측면 포켓 걸이 홀더(옵션품목): 수건걸이, 휴지봉투 전용.
(모델번호: HMR 1000)

- 1 Built-in refrigerator cabinet for effective utilization of space and flower patterned door (pattern applied to silk screen (optional)).
- 2 Socket tray placed in the dead space for convenient use of electrical appliances.
- 3 Side pocket hanger holder (options): both for towel hanger and waste paper bags.

Consulting Room

환자의 진료와 건강 증진을 위한 쾌적하고 안락한 진료환경을
제공합니다.

Both comfortable and pleasant medical environment is served
for patient's medical treatment and health promotion.



- 1 X-ray 필름을 볼 수 있는 뷰 박스와 모니터 거치가 가능한 일체형 테이블 프레임.(옵션품목)
- 2 환자 진료시 다리의 간섭을 최소화하는 하부 가림판과 프레임에 설계된 콘센트 유닛.
- 3 테이블 상판 아래에 안전하게 부착되는 CPU 홀더.
- 4 수납공간과 의자로도 사용 가능한 분리형 서랍박스과 쿠션 패드.

- 1 All-in-one table frame allowing a monitor and view box for viewing x-ray film (optional) to be mounted.
- 2 Socket unit present on the frame and lower modesty panel that minimizes leg interference during treatment of a patient.
- 3 CPU holder safely attached under the table's worktop.
- 4 Cushion pad and separation type drawer box that can be used as storage space and chairs.

Nurse Station - Cabinet

수납의 효율성 제고와 업무 동선을 위한 코너형 캐비닛 등 다양한 종류의 캐비닛으로 체계적인 공간을 만듭니다.

Create an effective space with various kinds of cabinets, including corner type cabinets, to improve storage efficiency and ensure a smooth workflow.



굿디자인
GOOD DESIGN



핀업디자인상
PIN UP
Design Awards



호주세계디자인상
Australian International
Design Award



1



2

- 1 고급스럽고 사용자의 안전을 고려한 도어 손잡이.
- 2 다량의 서류와 차트 등의 분류 보관이 용이하도록 캐비닛의 높이와 형태를 자유로이 구성할 수 있습니다.

- 1 High-class door knob designed in consideration of the safety of its users.
- 2 Can configure to various heights and types of cabinet for easy classification and storage of various documents and charts.

Nurse Station Preparation Room - Wall Storage



2



3

- 1 사이즈와 기능에 따른 다양한 품목 구성이 용이한 오픈 선반과 네임 플레이트.
- 2 인조 대리석 상판은 잦은 약 조제와 수분에 의한 변질이 적고, 옛지 부분에 턱을 주어 약물 등이 바닥으로 떨어지는 것을 방지합니다.
- 3 레버 방식의 고급형 싱크 수전은 장시간 사용에도 변색이 되지 않는 크롬 도금으로 마감하였습니다.

- 1 Open shelf and name plate allow for the organization of various items according to size and function.
- 2 The top of scagliola is resilient to frequent making of medicine and corruption by water. As an edge part is slightly higher than the top, it prevents dropping medicines.
- 3 A high-end lever-type sink faucet is chrome-plated to prevent discoloration for years.

Nurse Station Linen Room - Fitting Room

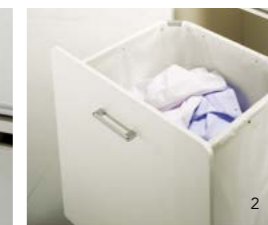

2

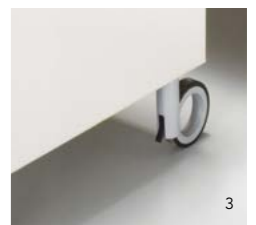

3



4

- 1 서류 운반 카트에 내장된 콘센트 유닛은 각종 전기구의 편리한 사용을 위해 설계되었습니다.
- 2 관리가 용이하도록 탈부착이 가능한 버튼식 햄퍼 패브릭 바구니.
- 3 차별된 디자인과 이동시 소음이 없는 카트의 볼 캐스터.
- 4 물품 카트의 바스켓은 디바이더로 분할이 가능하여 약물 보관이 자유롭습니다.

- 1 A consent unit is built into the document transportation cart and allows various electrical devices to be easily used.
- 2 A button type hamper fabric basket can be easily attached and removed.
- 3 A specially designed ball caster that is noiseless when moving.
- 4 The commodity cart's basket can be partitioned with a divider for easy storage of drugs.

Canteen

Meet a well-equipped office cafe

잘 차려진 오피스 카페를 만나다

도어로 답답했던 수납공간을 벗어나 오픈장 솔루션을 제안하는 유러피안 스타일입니다. 트렌디한 컬러와 디자인, 그리고 효율적인 레이아웃으로 카페와 같은 멋스러운 휴식 공간을 선사합니다.

This European style furniture suggests an open-wardrobe solution out of the stuffy storage space. With trendy colors, designs and efficient layout, it creates a stylish cafe-like rest area.



T Plan

인출식 선반을 적용하여 미니바, 보조테이블로의 활용은 물론 다양한 전자기기의 수납성을 향상시킨 기능성 키친장 등으로 편리함을 더했습니다.

By applying a pull-out shelf, we add convenience to use it as a mini bar and an auxiliary table, as well as a functional tall cabinet that offers the storage of various electronic devices.

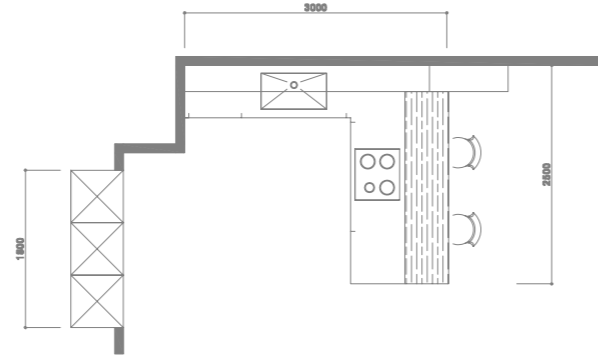

— Plan

간결한 동선으로 컴팩트 공간에 최적화된 플랜으로 연계형 식탁을 활용하여 좁은 공간에서의 공간활용이 극대화됩니다. It is the optimized plan for compact space with simple traffic line and makes the best use of the small space by using connectable table.

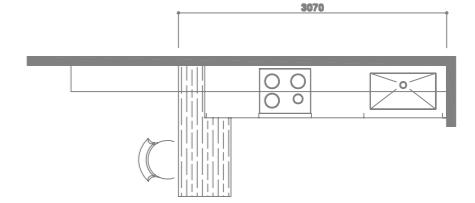



현대백화점의 안목을 담은 토탈 케어 브랜드
현대적 케어라이프 - 현대큐밍

Total care brand with discerning eyes of
Hyundai Department Store
Modern Care Life-Hyundai Quming



생활의 즐거움을 창조하는 토탈 홈케어 렌탈기업

신뢰와 끊임없는 혁신은 현대렌탈케어의 사명이자, 고객과의 약속이며 더 높은 가치와 목표를 이끌어내는 원동력입니다. 지난 40년간 지속적인 혁신을 통해 발전해온 현대백화점그룹의 프리미엄 서비스를 더 많은 고객에게 제공하고자, 2015년 4월에 현대렌탈케어라는 새로운 기업이 출범하였습니다.

해마다 성장하는 렌탈 시장 속에서, 현대렌탈케어는 그룹사와의 협력을 통하여 더 많은 고객에게 다가가려 노력하고 있습니다. 고객과의 만남부터 사후관리까지, 고객과 소통하며 고객의 삶 전반에서 함께 생활하는 기업이 되고자 합니다. 렌탈서비스와 케어서비스를 주축으로 차별적인 가치를 구축하고, 더 나아가 지역사회와의 상생관계를 구축하는 사회적 책임을 실천해갈 것입니다. 새로운 라이프스타일을 창조하는 혁신적인 도전은 현대렌탈케어가 만들어갈 역사입니다.

Total homecare rental company that creates joy of living

Trust and constant innovation are the mission of Hyundai Rental Care, a promise to our customers, and a driving force for higher values and goals. In April 2015, a new company called Hyundai Rental Care was launched to provide more customers with premium services of Hyundai Department Store Group, which has developed through continuous innovation for the past 40 years.

In the rental market growing every year, Hyundai Rental Care is trying to reach more customers through cooperation with group companies. From meeting with customers to follow-up management, we want to be a company that communicates with customers and lives together throughout their lives. We will build differentiated values based on rental services and care services, and further fulfill our social responsibilities to build win-win relationships with local communities. The innovative challenge of creating a new lifestyle is the history that Hyundai Rental Care will make.

<현대렌탈케어의 핵심가치>

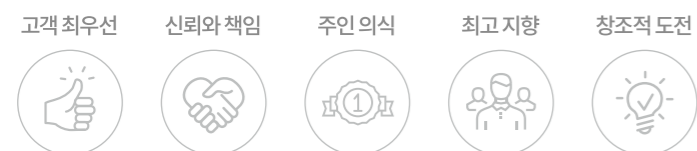

사업 소개 Business

현대큐밍은 우수한 제품으로 고객님의 건강하고 특별한 서비스를 제공하는 것을 목표로 하고 있습니다. 다양한 제품과 전문적인 사후 관리, 최상의 렌탈 서비스와 합리적인 가격으로 고객님의 이상적인 가치를 제공할 것입니다.

Hyundai Quming aims to provide healthy and special services to our customers with excellent products. We will provide ideal value to customers with various products, professional after-care, best rental service and reasonable price.

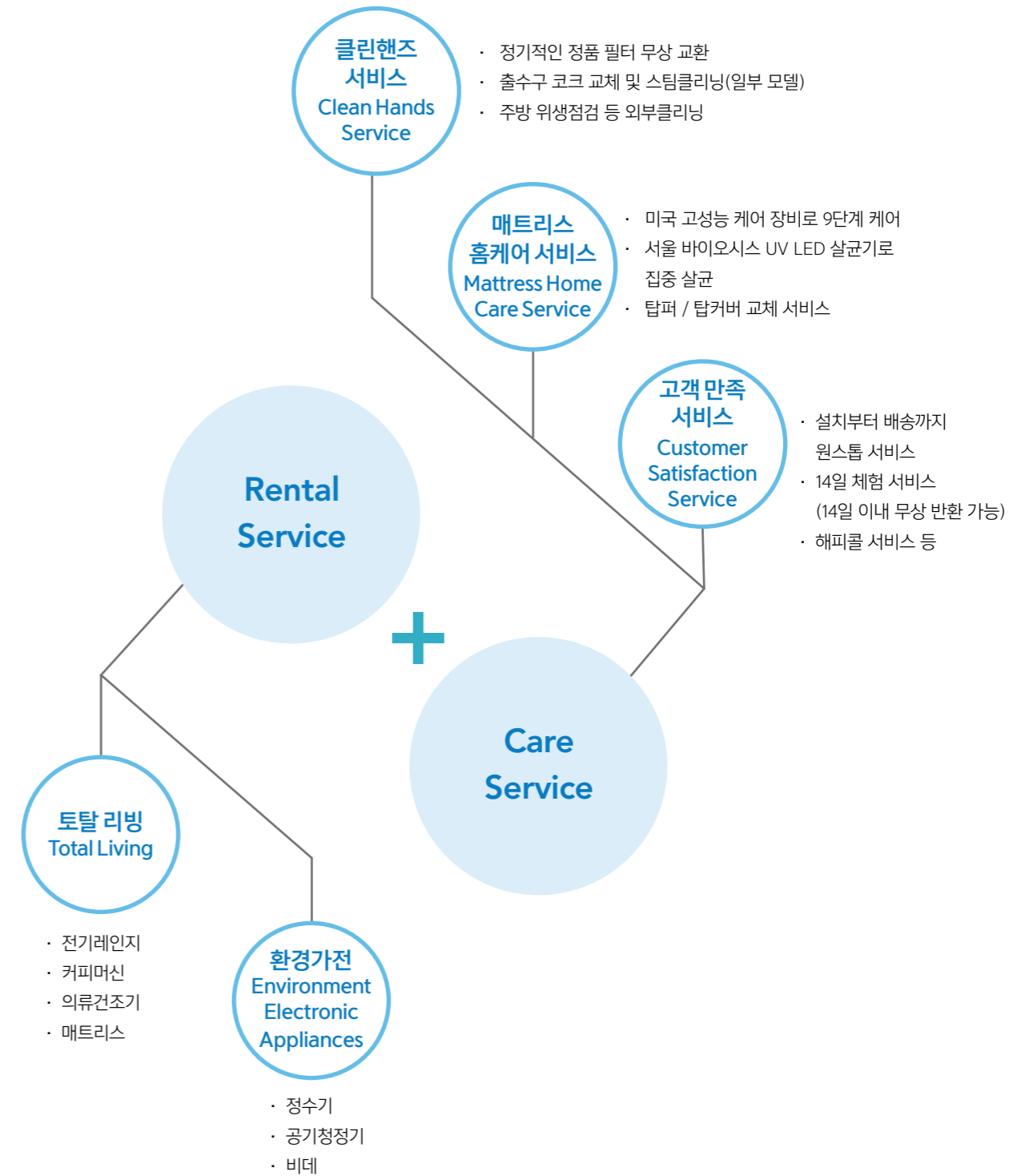

현대렌탈케어만의 특별한 제안

Hyundai Rental Care's special offer

현대큐밍은 다양한 제품과 전문적인 사후 관리, 최상의 렌탈 서비스와 합리적인 가격으로 고객님의 이상적인 가치를 제공합니다. 우수한 제품으로 고객님의 건강하고 특별한 서비스를 제공하겠습니다.

Hyundai Quming offers ideal value to its customers with a wide range of products, professional aftercare, best rental service and reasonable prices. We will provide healthy and special services to our customers with excellent products. Difference in cleanliness difference in water taste, fresher and healthier

Tel. 1800-8888

정수기 Water Purifier

깨끗함의 차이가 물 맛의 차이, 더 신선하게 더 건강하게
Mark-I medium and large capacity cold and hot water purifier



마크-1 중·대용량 냉온정수기

Mark-I medium and large capacity cold and hot water purifier
HP-751/752

- 넉넉한 용량의 정수기로 다중이용시설에 적합
- 소비자 사용패턴에 맞춘 출수구 디자인(냉수 사용이 많은 사용자 맞춤형)
- 조도센서 기능으로 전기료 절감 효과
- 4개월 주기 코크 교체 서비스 제공
- Large capacity water purifier suitable for multi-use facilities
- Outlet design according to consumer usage pattern (customized for users who use a lot of cold water)
- Electricity savings by the illumination sensor function
- 4 month cycle coke replacement service



Color. 화이트 / 티탄

큐밍 S 플러스 냉온정수기

Quming S Plus Cold & Hot Water Purifier
HQ-P1930

- 연속 출수 가능한 코크 레버(냉/온/정수)
- 풀 스테인리스 저수조로 위생 클리닝
- 실퍼파우더 함유 필터 탑재
- 4개월 주기 코크 교체 서비스 제공
- Coke lever (cold / hot / clean water) to enable continuous water discharge
- Sanitary cleaning with full stainless steel reservoir
- It is equipped with silver powder filter
- 4 month cycle coke replacement service



Color. 화이트 / 실버

공기청정기 Air Purifier

초미세먼지와 냄새까지 케어하여 모든 공간을 더 청정하게
Care of ultra fine dust and odors, making all spaces cleaner



큐밍 더케어 공기청정기 Quming 'The CARE' Air Purifier HA-832/831

- 1대 가격으로 2대 렌탈 : 하나의 대용량 공기청정기로는 벽너머 공간까지 케어할 수 없는 단점 보완
- 360° 흡입, 3ways 배출 : 하단 에어홀로 360° 먼지 흡입, 상단과 양쪽 에어홀로 3ways 청정 공기 배출
- 각종 측정 및 제어 기능 센서
- 초미세먼지(PM2.5), 극초미세먼지(PM1.0), 가스까지 감지
- 센서 표기값에 따라 공기상태 색상별 디스플레이
- Rental of two at the price of one: It compensates for the disadvantage that one large-capacity air cleaner cannot cover space beyond the wall
- 360° suction, 3ways exhaust: 360° dust inhalation to the bottom air hole, 3ways clean air exhaust to the upper and both air holes
- Sensors for various measurement and control functions
- Ultrafine dust (PM2.5), ultrafine dust (PM1.0), gas detection
- Display by the air color according to sensor reading



큐밍 더블에어 알파 공기청정기 Quming 'Double Air-Alpa' Air Purifier HQ-A19700

- 넓은 공간에 적합한 중·대용량 공기청정기
- 전후면 양면으로 집진 가능한 듀얼 필터 적용
- 공기오염도에 따라 자동으로 풍량 조절 되는 스마트 운전
- Medium and large capacity air cleaners suitable for large spaces
- Dual filter to collect dust on both sides
- Smart operation that automatically adjusts the air volume according to air pollution



비데 Bidet

전해수 살균 기능으로 사계절 내내 안심 케어
Safe care throughout the four seasons with electrolytic water sterilization

큐밍 안심케어 비데 Quming 'Safety care' Bidet HB-850

- 전기분해 살균수를 이용한 탱크/유로/노즐 살균
- 노즐팁, 노즐봉 자동세척은 기본 노즐팁 교체까지 서비스
- 일반절전 기능 및 파워 절전 기능으로 전기료 절약
- Tank / Flow path / Nozzle sterilization using electrolytic sterilization water
- For nozzle tip and nozzle rod automatic cleaning, service until basic nozzle tip replacement
- Electricity saving by power saving function and power saving function



Business Area

Showroom



송파전시장 Songpa

서울특별시 송파구 송이로 136 폭스바겐 빌딩 3, 4층
3rd and 4th Floors, Volkswagen Building, 136, Songi-ro, Songpa-gu, Seoul
Tel. 02-540-3693 / 82-02-540-3693



부산전시장 Busan

부산광역시 해운대구 해운대로 743 정우빌딩 5층
5th Floor, Jeongwoo Building, 743, Haeun-daero, Haeundae-gu, Busan
Tel. 051-791-0710 / 82-51-791-0710

Business Area

Showroom



울산전시장 Ulsan

울산광역시 북구 명촌10길 62
62, Myeongchon 10-gil, Buk-gu, Ulsan
Tel. 052-289-4358 | 82-52-289-4358



광주 전시장 Gwangju

광주광역시 서구 상무대로 903
908 Sangmu-daero, Seo-gu, Gwangju
Tel. 062-941-9600 | 82-62-941-9600

Factories



대전전시장 Daejeon

대전광역시 대덕구 계족로 552 1,2층 운영사무실
1st and 2nd floors, Operating Office, 552, Gyejok-ro, Daedeok-gu, Daejeon
Tel. 042-710-0760 / 82-42-710-0760



수지전시장 Suji

경기도 용인시 수지구 수지로 422
422 Suji-ro, Suji-gu, Yongin-si, Gyeonggi-do
Tel. 031-265-0701 | 82-31-265-0701



용인 본사 Yongin HQ

경기도 용인시 처인구 남사면 경기동로 316
316, Gyeonggidong-ro, Namsa-myeon, Cheoin-gu, Yongin-si, Gyeonggi-do
Tel. 1577-3332 | 82-1577-3332



안성 공장 Anseong

경기도 안성시 공도읍 기업단지 122-1
122-1, Gieopdanji-ro, Gongdo-eup, Anseong-si, Gyeonggi-do
Tel. 070-7204-4405 | 82-70-7204-4405

Branch

울산 Ulsan

울산광역시 북구 명촌 10길 62
62, Myeongchon 10-gil, Buk-gu, Ulsan
Tel. 052-289-4358 / 82-52-289-4358

광주 Gwangju

광주광역시 서구 상무대로 903
908 Sangmu-daero, Seo-gu, Gwangju
Tel. 062-941-9600 | 82-62-941-9600

C/S & Contact Us



서울·경인지역 / 원주·강원지역
대전·충청지역 / 전북(전주이북)지역
02-3014-2532

Seoul-Gyeongin Area
Wonju-Gangwon Area
Daejeon-Chungcheong Area
Jeonbuk(north of Jeonju) Area
82-2-3014-2532



대구·경북지역
부산·울산·경남지역
052-289-4358

Daegu-Gyeongbuk Area
Busan-Ulsan-Gyeongnam Area
82-52-289-4358



광주·전남지역
전북(전주이남)지역 / 제주도
062-941-9600

Gwangju-Jeonnang Area
Jeonbuk(south of Jeonju) Area
Jeju-do
82-62-941-9600

전국 C/S안내 National C/S Center

본사 Headquarters

경기도 용인시 처인구 남사면 경기동로 316
316 Gyeonggi-dong-ro, Namsa-myeon, Cheoin-gu,
Yongin City, Gyeonggi-do

서울사무소 Seoul Office

서울특별시 강남구 강남대로 566(논현동)
566 Gangnam-daero (Nonhyeon-dong), Gangnam-gu, Seoul
서울특별시 강동구 올림픽로 753(암사동)
753, Olympic-ro, Gangdong-gu(Amsa-dong), Seoul

소비자상담실 Customer Service Center

1577-3332
82-1577-3332

대리점 개설상담/제품 구매

New Dealership Consultation / Product Purchase

네오스영업팀(경인)	02-3014-2514, 2517
네오스영업팀(울산)	052-289-4358
네오스영업팀(광주)	062-941-9600
하움영업팀	02-3014-2509
Neoce Sales Team(Gyeongin)	82-2-3014-2532
Neoce Sales Team(Ulsan)	82-52-289-4358
Neoce Sales Team(Gwangju)	82-62-941-9600
Haum Sales Team	82-2-3014-2509

수출관련 Export Consultation

해외영업팀	02-3014-2542, 2543
Overseas Sales Team	82-2-3014-2542, 2543

제품개발/디자인 Product Development/Design

네오스개발팀	02-3014-2549
NEOCE Development Dept Team	82-2-3014-2549

Global Network



Contact Us

General Management

Tel. 82-2-3014-2536
Fax. 82-2-3014-2519
e-mail. freemk79@gmail.com

Asia & Others

Tel. 82-2-3014-2537
Fax. 82-2-3014-2519
e-mail. holee2525@gmail.com

Middle East & Africa

Tel. 82-2-3014-2540
Fax. 82-2-3014-2519
e-mail. park.livart@gmail.com

America & Oceania

Tel. 82-2-3014-2543
Fax. 82-2-3014-2519
e-mail. bart.livart@gmail.com

서울사무소 서울시 강동구 올림픽로 753 tel. 02-3014-2532
송파전시장 서울시 송파구 송이로 136 tel.02-540-3693
부산전시장 부산광역시 해운대구 해운대로 743 Tel. 051-791-0710
대전전시장 대전광역시 대덕구 계족로 552 Tel. 042-710-0760
수지전시장 경기도 용인시 수지구 수지로 422 tel.031-265-0701
울산전시장 울산광역시 북구 명촌 10길 62 tel.052-289-4358
광주전시장 광주광역시 서구 상무대로 903 tel.062-941-9600

www.hyundailivart.co.kr

- 본 카탈로그에 수록된 사진은 실물과 다를 수 있으므로 구입 전 반드시 확인하시기 바랍니다.
- 표시된 규격, 디자인은 설계 및 생산공정상 변경될 수 있습니다.
- The photos in this catalog can differ from actual furniture.
Be sure to check actual furniture before purchase.
- The sizes and designs indicated here are subject to change depending on situations involved with product design and manufacturing.



제작일 : 2019년 12월 발행
Date of Publication : December 2019